



**ИНТУБАЦИЯ
ТРАХЕОСТОМИЯ
КАТЕТЕРЫ**



Компания SUMI является ведущим в Польше производителем медицинских расходных материалов одноразового использования. Более чем 30-летний опыт гарантирует их соответствие высшим качественным требованиям и успешное использование в отделениях анестезиологических, интенсивной терапии, операционных и в спасательной медицинской службе.

Среди наших клиентов числится большинство больниц и клиник в Польше, а также медицинские учреждения в более чем 30-ти странах Европы, Азии и Африки. Нашей целью, достигаемой путем внедрения современных технологических решений, является постоянное развитие и беспрестанное совершенствование наших изделий. Мы открыты для любых предложений и пожеланий клиентов производя изделия на заказ, и заодно учитывая их замечания в будущих прогрессивных проектах.

Все изделия компании SUMI сертифицированы с сертификатом соответствия CE согласно директиве 93/42/EEC. С 2003 года компания действует по правилам Системы управления качеством ISO 9001:2008 и ISO 13485:2012.



Предложение SUMI охватывает:

- эндотрахеальные трубки с принадлежностями
- эндобронхиальные трубки
- трахеостомические трубки с принадлежностями
- стилеты (проводники)
- ларингеальные маски
- наконечники для аспирации операционного поля
- катетеры, желудочные и дуоденальные зонды
- замкнутые отсосные системы
- дренажные, удлинительные и соединительные трубки



Более подробную информацию Вы можете узнать на сайте www.sumi.com.pl

Table of contents

Tracheal tubes

Tracheal tube with low pressure cuff	p. 4
Tracheal tube with low pressure cuff	p. 4
Tracheal tube with low pressure cuff, with stylet	p. 5
Tracheal tube with extra high volume low pressure cuff	p. 5
Tracheal tube without cuff	p. 6
Tracheal tube without cuff, soft	p. 6
Reinforced tracheal tube without cuff	p. 7
Reinforced tracheal tube with low pressure cuff	p. 7
Tracheal tube with suction lumen	p. 8
Microlaryngeal tracheal tube	p. 8
Preformed tracheal tube, nasal soft	p. 9
Preformed tracheal tube, nasal	p. 9
Preformed tracheal tube, oral	p. 10
Preformed tracheal tube, oral – forehead	p. 10

Bronchial tubes

Double lumen bronchial tube – left sided	p. 11
Double lumen bronchial tube – left sided, set	p. 11
Double lumen bronchial tube - right sided	p. 12
Double lumen bronchial tube – right sided, set	p. 12
Tracheostomy double lumen bronchial tube - left sided	p. 13
Tracheostomy double lumen bronchial tube - right sided	p. 13
Single lumen bronchial tube - left sided	p. 14
Single lumen bronchial tube - right sided	p. 14
Bronchial tube connectors set	p. 15

Masks, airway and accessories

Silicone laryngeal mask, reusable	p. 16
New Silicone laryngeal mask, single use	p. 16
Laryngeal mask, single use	p. 16
Nasopharyngeal airway	p. 17
Guedel airway	p. 17
Tracheal intubation stylet	p. 18
Tracheal tube guide	p. 18
Tracheal tube introducer	p. 19
Tracheal tube introducer for infants	p. 19
Tracheal tube guide with ventilation lumen	p. 20
Bite blocks for tracheal tubes	p. 20
Tracheal tube holder, two-piece	p. 21
New Tracheal tube holder, one-piece	p. 21
Disconnecting wedge	p. 21
Extendible catheter mounts	p. 22
Corrugated catheter mounts	p. 23
Smooth bore catheter mounts	p. 24
Double swivel elbow connectors	p. 25
Tracheal tube connectors set	p. 25
Silicone corrugated breathing tube	p. 25
Closed suction system 24h, 72h	p. 26
Closed suction system 24h, 72h, pediatric	p. 27

Tracheostomy tubes

Tracheostomy tube with high volume low pressure cuff	p. 30
Tracheostomy tube with double cuff	p. 30
Tracheostomy tube without cuff	p. 31
Tracheostomy tube without cuff, fenestrated	p. 31
Tracheostomy tube with adjustable flange	p. 32
Tracheostomy tube with adjustable flange, long	p. 32
Reinforced tracheostomy tube with adjustable flange	p. 33
Reinforced tracheostomy tube with adjustable flange, long	p. 33
Reinforced tracheostomy tube, straight	p. 34
New Reinforced tracheostomy tube, extra long, arced	p. 34
Tracheostomy tube with suction lumen	p. 35
Montandon type tube	p. 35
New SUMINI paediatric tracheostomy tube with cuff	p. 37
New SUMINI paediatric tracheostomy tube without cuff	p. 37
New SUMINI neonate tracheostomy tube with cuff	p. 38
New SUMINI neonate tracheostomy tube without cuff	p. 38

KAN tracheostomy tubes

KAN tracheostomy tube without cuff	p. 40
KAN tracheostomy tube without cuff, fenestrated	p. 41
KAN tracheostomy tube with cuff	p. 42
KAN tracheostomy tube with cuff, fenestrated	p. 43
KAN laryngectomy tube	p. 44
KAN laryngectomy tube, fenestrated	p. 45
KAN tracheostomy tube with suction lumen	p. 46
Heat and moisture exchanger	p. 47
New Accessories for KAN and tracheostomy tubes	p. 48-49

Suction handles, tubing, catheters

Suction handle with filter, set	p. 51
Suction handles – various types and sets	p. 51-55
Connecting tubes	p. 54-55
Tubing – standard, bubble, silicone	p. 56
New Tubing connectors	p. 57
New HiCapno oxygen mask	p. 58
Nasal oxygen set	p. 59
Oxygen connecting tube	p. 59
New Oxygen connecting tube connector	p. 59
Feeding tube	p. 60
Control valve suction catheter	p. 60
Stomach and duodenal tubes	p. 61
Urology catheters	p. 61

Tracheal tubes

SUMI offers wide range of disposable products for airway management.

Among them there are many different endotracheal tubes: standard, reinforced, microlaryngeal, with suction lumen. Special attention shall be paid to bronchial tubes which are great appreciated by many professionals worldwide.

Endotracheal range includes also many useful accessories such us: introducers, stylets, holders as well as Guedel airway, nasopharyngeal airway, laryngeal mask.

SUMI endotracheal tubes are made of medical thermosensitive PVC, latex free and phthalate free. Majority of our products are available in siliconised version. This improves wall smoothness and gives anti-adhesive properties.

Starting from precise design, best material and great performance, we finally give variety of top quality airway management products in widest size choice.

Main features of SUMI tracheal tubes:

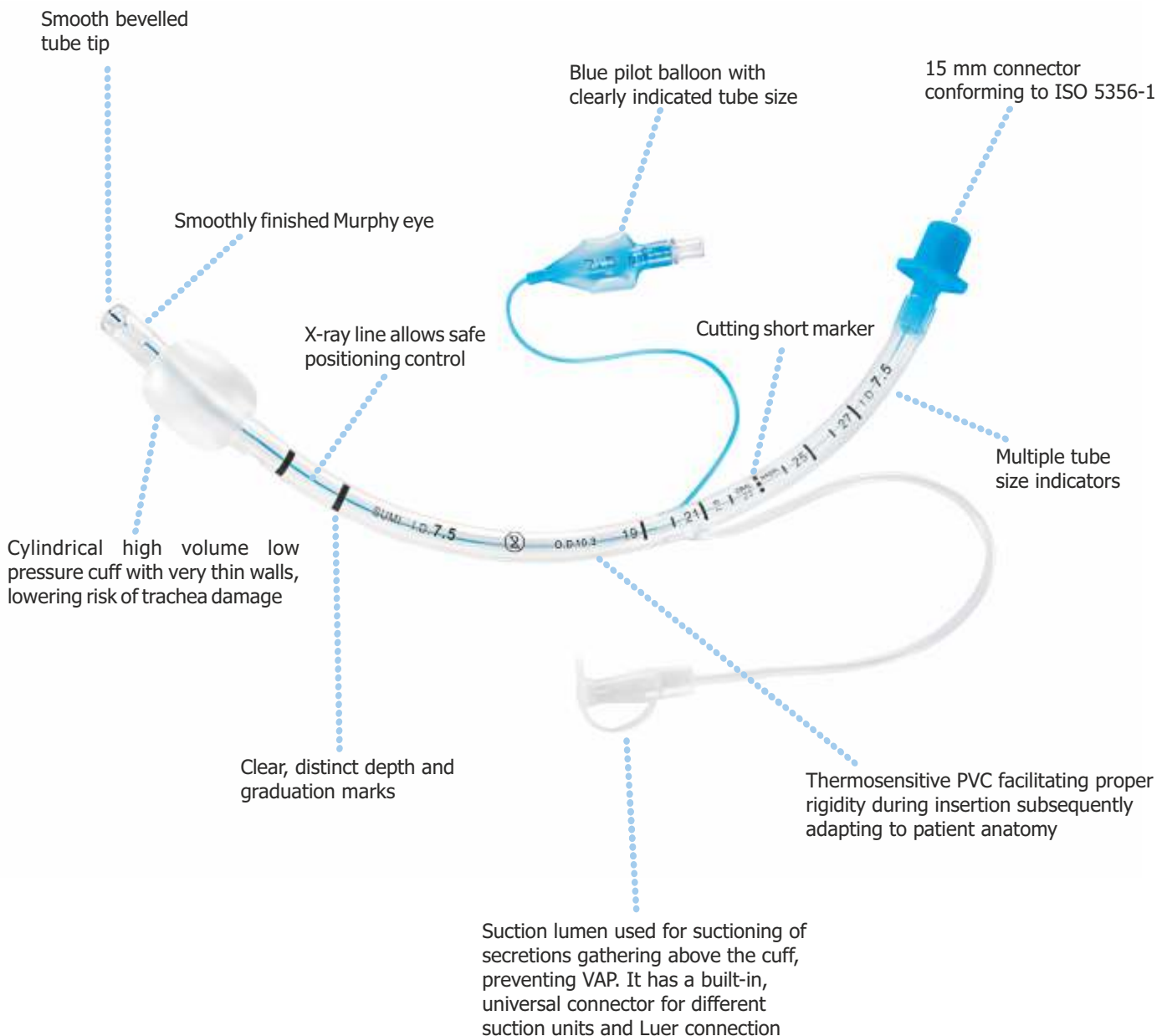

Tracheal tube with low pressure cuff



- oral – nasal
- Murphy type
- made of thermosensitive PVC
- transparent
- high volume low pressure cuff
- X-ray line
- clear tube markings
- marked pilot balloon
- transparent 15 mm connector
- wide black ring depth mark
- latex free
- sterile, single use

size I.D. [mm]	O.D. [mm]	Ø cuff [mm]	reference number	
			PVC	PVC siliconised
3,0	4,2	12,0	02-3000	02-3010
3,5	4,9	12,0	02-3500	02-3510
4,0	5,5	14,0	02-4000	02-4010
4,5	6,2	14,0	02-4500	02-4510
5,0	6,9	17,0	02-5000	02-5010
5,5	7,5	17,0	02-5500	02-5510
6,0	8,2	20,0	02-6000	02-6010
6,5	8,8	20,0	02-6500	02-6510
7,0	9,6	25,0	02-7000	02-7010
7,5	10,2	25,0	02-7500	02-7510
8,0	10,9	26,0	02-8000	02-8010
8,5	11,5	26,0	02-8500	02-8510
9,0	12,1	28,0	02-9000	02-9010
9,5	12,7	28,0	02-9500	02-9510
10,0	13,6	28,0	02-1000	02-1010

Tracheal tube with low pressure cuff



- improved tube flexibility
- oral – nasal
- Murphy type
- made of thermosensitive PVC, siliconised
- transparent
- high volume low pressure cuff
- X-ray line
- clear tube markings
- marked pilot balloon
- different types of depth markings, available
- latex free, phthalate free
- sterile, single use

size I.D. [mm]	O.D. [mm]	Ø cuff [mm]	reference number
2,0	3,0	7,0	02-2012
2,5	3,5	8,0	02-2512
3,0	4,2	8,0	02-3012
3,5	4,8	10,0	02-3512
4,0	5,4	10,0	02-4012
4,5	6,0	12,0	02-4512
5,0	6,9	14,0	02-5012
5,5	7,5	17,0	02-5512
6,0	8,2	20,0	02-6012
6,5	8,8	20,0	02-6512
7,0	9,7	23,0	02-7012
7,5	10,3	25,0	02-7512
8,0	11,0	26,0	02-8012
8,5	11,7	27,0	02-8512
9,0	12,3	29,0	02-9012
9,5	13,0	29,0	02-9512
10,0	13,7	32,0	02-1012

Tracheal tube with low pressure cuff, with stylet

- improved tube flexibility
- oral – nasal
- Murphy type
- made of thermosensitive PVC, siliconised
- transparent
- extra high volume low pressure cuff
- X-ray line
- clear tube markings
- marked pilot balloon
- different types of depth markings, available
- pre-inserted stylet
- latex free, phthalate free
- sterile, single use



size I.D. [mm]	O.D. [mm]	Ø cuff [mm]	reference number
2,5	3,5	8,0	02-2514
3,0	4,2	8,0	02-3014
3,5	4,8	10,0	02-3514
4,0	5,4	10,0	02-4014
4,5	6,0	12,0	02-4514
5,0	6,9	14,0	02-5014
5,5	7,5	17,0	02-5514
6,0	8,2	20,0	02-6014
6,5	8,8	20,0	02-6514
7,0	9,7	23,0	02-7014
7,5	10,3	25,0	02-7514
8,0	11,0	26,0	02-8014
8,5	11,7	27,0	02-8514
9,0	12,3	29,0	02-9014
9,5	13,0	29,0	02-9514
10,0	13,7	32,0	02-1014

Tracheal tube with extra high volume low pressure cuff

- improved tube flexibility
- oral – nasal
- Murphy type
- made of thermosensitive PVC, siliconised
- transparent
- extra high volume low pressure cuff with thin walls
- recommended for long – term ventilation
- X-ray line
- clear tube markings
- marked pilot balloon
- latex free, phthalate free
- sterile, single use



size I.D. [mm]	O.D. [mm]	Ø cuff [mm]	reference number
5,0	6,9	20,0	08-5095
5,5	7,5	20,0	08-5595
6,0	8,2	25,0	08-6095
6,5	8,8	25,0	08-6595
7,0	9,7	28,0	08-7095
7,5	10,3	28,0	08-7595
8,0	11,0	30,0	08-8095
8,5	11,7	30,0	08-8595
9,0	12,3	34,0	08-9095
9,5	13,0	34,0	08-9595
10,0	13,7	34,0	08-1095

Tracheal tube without cuff

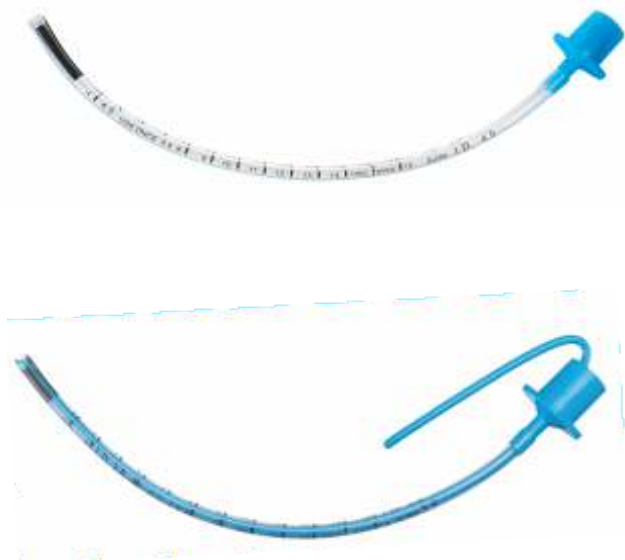

- oral – nasal
- Murphy type
- made of thermosensitive PVC
- transparent
- X-ray line
- clear tube and depth markings
- double graduation mark at each cm
- latex free, phthalate free
- sterile, single use

size I.D. [mm]	O.D. [mm]	reference number		
		PVC	PVC siliconised	PVC siliconised with stylet
2,0	3,0	04-2000	04-2010	-
2,5	3,5	04-2500	04-2510	04-2514
3,0	4,2	04-3000	04-3010	04-3014
3,5	4,8	04-3500	04-3510	04-3514
4,0	5,4	04-4000	04-4010	04-4014
4,5	6,0	04-4500	04-4510	04-4514
5,0	6,9	04-5000	04-5010	04-5014
5,5	7,5	04-5500	04-5510	04-5514
6,0	8,2	04-6000	04-6010	04-6014
6,5	8,8	04-6500	04-6510	04-6514
7,0	9,7	04-7000	04-7010	04-7014
7,5	10,3	04-7500	04-7510	04-7514
8,0	11,0	04-8000	04-8010	04-8014
8,5	11,7	04-8500	04-8510	04-8514
9,0	12,3	04-9000	04-9010	04-9014
9,5	13,0	04-9500	04-9510	04-9514
10,0	13,7	04-1000	04-1010	04-1014

Tracheal tube without cuff, soft



- oral - nasal
- Murphy type
- made of thermosensitive PVC, siliconised
- transparent
- recommended for long – term ventilation
- X-ray line
- clear tube and depth markings
- double graduation mark at each cm
- extra soft
- latex free, phthalate free
- sterile, single use

size I.D. [mm]	O.D. [mm]	reference number
2,0	3,3	07-2010
2,5	4,0	07-2510
3,0	4,5	07-3010
3,5	5,1	07-3510
4,0	5,8	07-4010
4,5	6,5	07-4510
5,0	7,3	07-5010
5,5	8,0	07-5510
6,0	8,6	07-6010
6,5	9,2	07-6510
7,0	9,7	07-7010
7,5	10,3	07-7510
8,0	11,0	07-8010
8,5	11,7	07-8510
9,0	12,3	07-9010
9,5	13,0	07-9510
10,0	13,7	07-1010

Reinforced tracheal tube without cuff

- oral - nasal
- Murphy type
- made of thermosensitive PVC
- reinforcement made of stainless steel
- kink – resistant
- curved shape
- clear tube markings
- glued-in connector
- available with stylet
- latex free, phthalate free
- sterile, single use



size I.D. [mm]	O.D. [mm]	reference number		
		PVC	PVC siliconised	PVC siliconised with stylet
2,0	3,5	14-2000	14-2010	-
2,5	4,2	14-2500	14-2510	14-2514
3,0	4,8	14-3000	14-3010	14-3014
3,5	5,4	14-3500	14-3510	14-3514
4,0	6,0	14-4000	14-4010	14-4014
4,5	6,9	14-4500	14-4510	14-4514
5,0	7,5	14-5000	14-5010	14-5014
5,5	8,2	14-5500	14-5510	14-5514
6,0	8,8	14-6000	14-6010	14-6014
6,5	9,7	14-6500	14-6510	14-6514
7,0	10,2	14-7000	14-7010	14-7014
7,5	11,0	14-7500	14-7510	14-7514
8,0	11,6	14-8000	14-8010	14-8014
8,5	12,3	14-8500	14-8510	14-8514
9,0	12,9	14-9000	14-9010	14-9014
9,5	13,7	14-9500	14-9510	14-9514
10,0	14,2	14-1000	14-1010	14-1014

Reinforced tracheal tube with low pressure cuff

- oral - nasal
- Murphy type
- made of thermosensitive PVC
- high volume low pressure cuff
- reinforcement made of stainless steel
- kink – resistant
- curved shape
- clear tube markings
- glued-in connector
- available with stylet
- marked pilot balloon
- latex free, phthalate free
- sterile, single use



size I.D. [mm]	O.D. [mm]	Ø cuff [mm]	reference number		
			PVC	PVC siliconised	PVC siliconised with stylet
2,5	4,2	8,0	12-2500	12-2510	12-2514
3,0	4,8	8,0	12-3000	12-3010	12-3014
3,5	5,4	10,0	12-3500	12-3510	12-3514
4,0	6,0	10,0	12-4000	12-4010	12-4014
4,5	6,9	12,0	12-4500	12-4510	12-4514
5,0	7,5	14,0	12-5000	12-5010	12-5014
5,5	8,2	17,0	12-5500	12-5510	12-5514
6,0	8,8	20,0	12-6000	12-6010	12-6014
6,5	9,7	20,0	12-6500	12-6510	12-6514
7,0	10,2	23,0	12-7000	12-7010	12-7014
7,5	11,0	25,0	12-7500	12-7510	12-7514
8,0	11,6	26,0	12-8000	12-8010	12-8014
8,5	12,3	27,0	12-8500	12-8510	12-8514
9,0	12,9	29,0	12-9000	12-9010	12-9014
9,5	13,7	29,0	12-9500	12-9510	12-9514
10,0	14,2	32,0	12-1000	12-1010	12-1014

Tracheal tube with suction lumen



- oral - nasal
- Murphy type
- made of thermosensitive PVC, siliconised
- transparent
- high volume low pressure cuff
- allows suctioning of secretions from above the cuff, minimizing the risk of infection
- suction lumen ended with universal connector
- X-ray line
- clear tube markings
- marked pilot balloon
- recommended for long – term ventilation
- latex free, phthalate free
- sterile, single use

size I.D. [mm]	O.D. [mm]	Ø cuff [mm]	reference number	
			without stylet	with stylet
5,0	7,6	20,0	06-5011	06-5014
5,5	8,3	23,0	06-5511	06-5514
6,0	9,0	23,0	06-6011	06-6014
6,5	9,7	23,0	06-6511	06-6514
7,0	10,4	26,0	06-7011	06-7014
7,5	11,0	27,0	06-7511	06-7514
8,0	11,7	30,0	06-8011	06-8014
8,5	12,2	32,0	06-8511	06-8514
9,0	12,8	36,0	06-9011	06-9014
9,5	13,4	36,0	06-9511	06-9514
10,0	14,2	36,0	06-1011	06-1014

Microlaryngeal tracheal tube

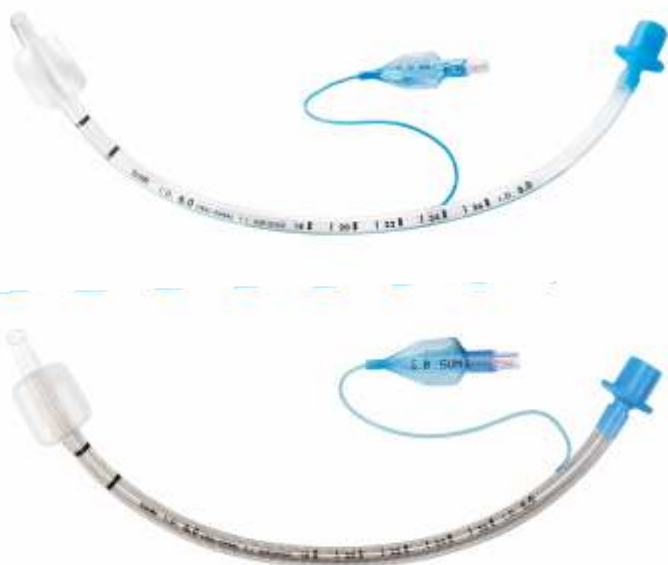

- oral – nasal
- elongate length of the tube
- Murphy type
- made of thermosensitive PVC, siliconised
- transparent
- extra high volume low pressure cuff with thin walls
- X-ray line
- clear tube markings
- marked pilot balloon
- latex free, phthalate free
- sterile, single use

size I.D. [mm]	O.D. [mm]	Ø cuff [mm]	length [mm]	reference number	
				non-reinforced	reinforced
4,0	5,4	20,0	368	05-4010	05-4012
5,0	6,9	25,0	368	05-5010	05-5012
6,0	8,2	28,0	368	05-6010	05-6012

Preformed tracheal tube, nasal, soft



- nasal
- Murphy type
- made of thermosensitive PVC, siliconised
- milky, non-transparent
- with high volume low pressure cuff or without cuff
- flexible, with thicker walls, non kinking
- curved towards the forehead
- designated for surgeries in head and neck area
- X-ray line
- clear tube markings
- marked pilot balloon
- latex free, phthalate free
- sterile, single use

size I.D. [mm]	O.D. [mm]	Ø cuff [mm]	reference number	
			with cuff	without cuff
3,0	4,5	8,0	27-3014	28-3014
3,5	5,1	10,0	27-3514	28-3514
4,0	6,0	10,0	27-4014	28-4014
4,5	6,7	12,0	27-4514	28-4514
5,0	7,3	14,0	27-5014	28-5014
5,5	8,0	17,0	27-5514	28-5514
6,0	8,8	20,0	27-6014	28-6014
6,5	9,4	20,0	27-6514	28-6514
7,0	10,2	23,0	27-7014	28-7014
7,5	10,8	25,0	27-7514	28-7514
8,0	11,6	26,0	27-8014	28-8014

Preformed tracheal tube, nasal



- nasal
- Murphy type
- made of thermosensitive PVC, siliconised
- transparent
- with high volume low pressure cuff or without cuff
- extra soft
- curved towards the forehead
- designated for surgeries in head area
- X-ray line
- clear tube markings
- marked pilot balloon
- latex free, phthalate free
- sterile, single use

size I.D. [mm]	O.D. [mm]	Ø cuff [mm]	reference number	
			with cuff	without cuff
3,0	4,2	8,0	27-3010	28-3010
3,5	4,8	10,0	27-3510	28-3510
4,0	5,4	10,0	27-4010	28-4010
4,5	6,0	12,0	27-4510	28-4510
5,0	6,9	14,0	27-5010	28-5010
5,5	7,5	17,0	27-5510	28-5510
6,0	8,2	20,0	27-6010	28-6010
6,5	8,8	20,0	27-6510	28-6510
7,0	9,7	23,0	27-7010	28-7010
7,5	10,2	25,0	27-7510	28-7510
8,0	11,0	26,0	27-8010	28-8010

Preformed tracheal tube, oral

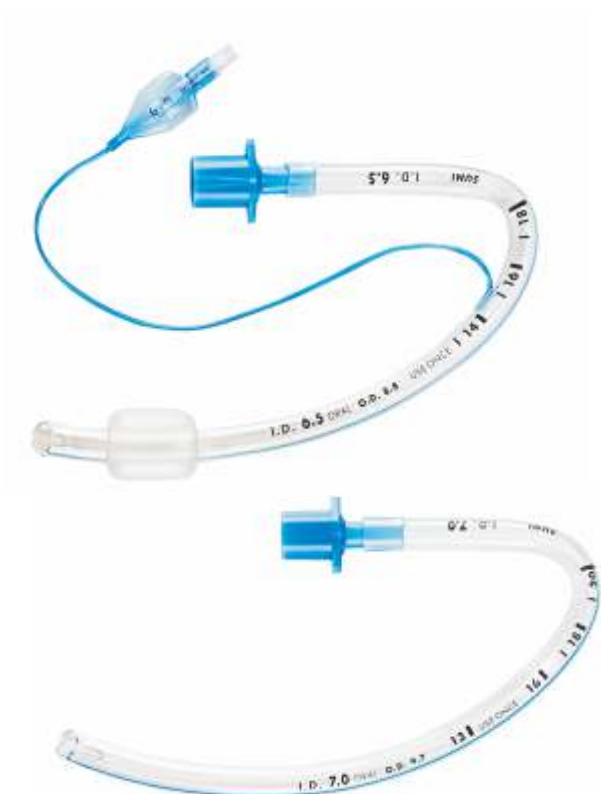

- oral
- Murphy type
- made of thermosensitive PVC, siliconised
- transparent
- with high volume low pressure cuff or without cuff
- curved towards the chin
- designated for surgeries in head area
- X-ray line
- clear tube markings
- marked pilot balloon
- latex free
- sterile, single use

size I.D. [mm]	O.D. [mm]	Ø cuff [mm]	reference number	
			with cuff	without cuff
3,0	4,2	8,0	25-3010	26-3010
3,5	4,8	10,0	25-3510	26-3510
4,0	5,4	10,0	25-4010	26-4010
4,5	6,0	12,0	25-4510	26-4510
5,0	6,9	14,0	25-5010	26-5010
5,5	7,5	20,0	25-5510	26-5510
6,0	8,2	20,0	25-6010	26-6010
6,5	8,8	20,0	25-6510	26-6510
7,0	9,7	23,0	25-7010	26-7010
7,5	10,2	25,0	25-7510	26-7510
8,0	11,0	26,0	25-8010	26-8010
8,5	11,6	27,0	25-8510	26-8510
9,0	12,3	29,0	25-9010	26-9010

Preformed tracheal tube, oral – forehead

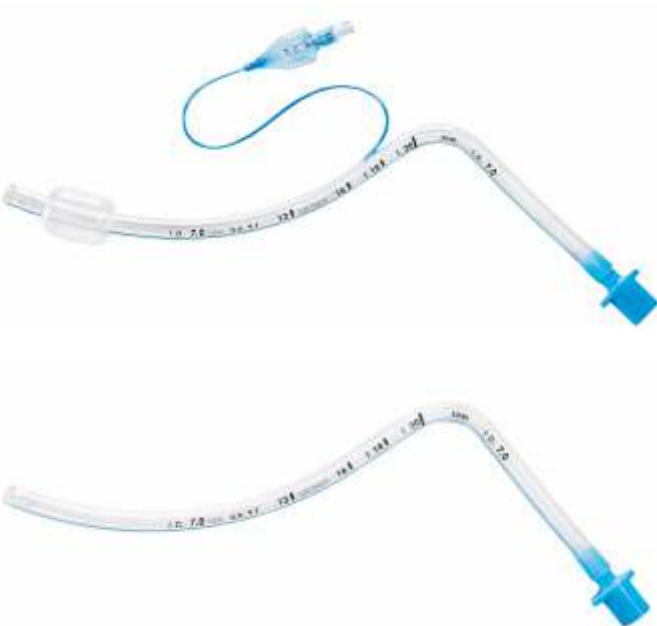

- oral
- Murphy type
- made of thermosensitive PVC, siliconised
- transparent
- with high volume low pressure cuff or without cuff
- curved towards the forehead
- designated for surgeries in head area
- X-ray line
- clear tube markings
- marked pilot balloon
- latex free, phthalate free
- sterile, single use

size I.D. [mm]	O.D. [mm]	Ø cuff [mm]	reference number	
			with cuff	without cuff
3,0	4,2	-	-	26-3037
3,5	4,8	-	-	26-3537
4,0	5,4	-	-	26-4037
4,5	6,0	-	-	26-4537
5,0	6,9	14,0	25-5037	26-5037
5,5	7,5	20,0	25-5537	26-5537
6,0	8,2	20,0	25-6037	26-6037
6,5	8,8	20,0	25-6537	26-6537
7,0	9,7	23,0	25-7037	26-7037
7,5	10,3	25,0	25-7537	26-7537
8,0	11,0	26,0	25-8037	26-8037
8,5	11,7	27,0	25-8537	26-8537
9,0	12,3	29,0	25-9037	26-9037

Double lumen bronchial tube – left sided



- made of thermosensitive PVC, siliconised
- two delicate high volume low pressure cuffs
- smooth walls preventing gathering of secretion
- atraumatic, rounded tip and smooth cuff welding
- X-ray line along the tube, additional X-ray marks assisting in accurate positioning of the tube
- stylet covered with medical plastic
- marked pilot balloons
- graduation mark
- two 15 mm connectors conforming to ISO 5356-1
- latex free, phthalate free
- sterile, single use

size [CH/FG]	Ø _B cuff [mm]	Ø _T cuff [mm]	reference number	
			-	with carina hook
24	12,0	14,0	21-2410	-
26	15,0	20,0	21-2610	-
28	16,0	20,0	21-2810	-
32	16,0	21,0	21-3210	21-3241
35	18,0	23,0	21-3510	21-3541
37	18,0	25,0	21-3710	21-3741
39	20,0	30,0	21-3910	21-3941
41	22,0	32,0	21-4110	21-4141

Double lumen bronchial tube – left sided, set



Set contains:

- bronchial tube, left sided
- connectors set, with or without clamps
- 4 control valve suction catheters

size [CH/FG]	Ø _B cuff [mm]	Ø _T cuff [mm]	reference number		
			bronchial tube		
			connectors without clamps	connectors with clamps	carina hook, connectors with clamps
24	12,0	14,0	21-2420	21-2422	-
26	15,0	20,0	21-2620	21-2622	-
28	16,0	20,0	21-2820	21-2822	-
32	16,0	21,0	21-3220	21-3222	21-3245
35	18,0	23,0	21-3520	21-3522	21-3545
37	18,0	25,0	21-3720	21-3722	21-3745
39	20,0	30,0	21-3920	21-3922	21-3945
41	22,0	32,0	21-4120	21-4122	21-4145

Double lumen bronchial tube - right sided



- made of thermosensitive PVC, siliconised
- two delicate high volume low pressure cuffs
- smooth walls preventing gathering of secretion
- atraumatic, rounded tip and smooth cuff welding
- X-ray line along the tube, additional X-ray marks assisting in accurate positioning of the tube
- stylet covered with medical plastic
- marked pilot balloons
- graduation mark
- two 15 mm connectors conforming to ISO 5356-1
- latex free, phthalate free
- sterile, single use

size [CH/FG]	Ø _B cuff [mm]	Ø _T cuff [mm]	reference number	
			-	with carina hook
24	12,0	14,0	22-2410	-
26	15,0	20,0	22-2610	-
28	16,0	20,0	22-2810	-
32	16,0	21,0	22-3210	22-3241
35	18,0	23,0	22-3510	22-3541
37	18,0	25,0	22-3710	22-3741
39	20,0	30,0	22-3910	22-3941
41	22,0	32,0	22-4110	22-4141

Double lumen bronchial tube – right sided, set



Set contains:

- bronchial tube, right sided
- connectors set, with or without clamps
- 4 control valve suction catheters

size [CH/FG]	Ø _B cuff [mm]	Ø _T cuff [mm]	reference number		
			bronchial tube		
			connectors without clamps	connectors with clamps	carina hook, connectors with clamps
24	12,0	14,0	22-2420	22-2422	-
26	15,0	20,0	22-2620	22-2622	-
28	16,0	20,0	22-2820	22-2822	-
32	16,0	21,0	22-3220	22-3222	22-3245
35	18,0	23,0	22-3520	22-3522	22-3545
37	18,0	25,0	22-3720	22-3722	22-3745
39	20,0	30,0	22-3920	22-3922	22-3945
41	22,0	32,0	22-4120	22-4122	22-4145

Tracheostomy double lumen bronchial tube - left sided



- made of thermosensitive PVC, siliconised
- two delicate high volume low pressure cuffs
- smooth walls preventing gathering of secretion
- atraumatic, rounded tip and smooth cuff welding
- X-ray line along the tube
- stylet covered with medical plastic
- adjustable flange
- marked pilot balloons
- graduation mark
- two 15 mm connectors conforming to ISO 5356-1
- latex free, phthalate free
- sterile, single use

Set contains:

- bronchial tube, left sided
- connectors set, with or without clamps
- 4 control valve suction catheters

size/length [CH/mm]	\varnothing_b cuff [mm]	\varnothing_r cuff [mm]	reference number	
			left-sided tube	set
35/60	18,0	23,0	21-3560	21-3561
35/70	18,0	23,0	21-3570	21-3571
35/80	18,0	23,0	21-3580	21-3581
37/70	18,0	25,0	21-3770	21-3771
37/80	18,0	25,0	21-3780	21-3781
37/90	18,0	25,0	21-3790	21-3791
39/70	20,0	30,0	21-3970	21-3971
39/80	20,0	30,0	21-3980	21-3981
39/90	20,0	30,0	21-3990	21-3991

Tracheostomy double lumen bronchial tube - right sided



- made of thermosensitive PVC, siliconised
- two delicate high volume low pressure cuffs
- smooth walls preventing gathering of secretion
- atraumatic, rounded tip and smooth cuff welding
- X-ray line along the tube
- stylet covered with medical plastic
- adjustable flange
- marked pilot balloons
- graduation mark
- two 15 mm connectors conforming to ISO 5356-1
- latex free, phthalate free
- sterile, single use

Set contains:

- bronchial tube, right sided
- connectors set, with or without clamps
- 4 control valve suction catheters

size/length [CH/mm]	\varnothing_b cuff [mm]	\varnothing_r cuff [mm]	reference number	
			right-sided tube	set
35/60	18,0	23,0	22-3560	22-3561
35/70	18,0	23,0	22-3570	22-3571
35/80	18,0	23,0	22-3580	22-3581
37/70	18,0	25,0	22-3770	22-3771
37/80	18,0	25,0	22-3780	22-3781
37/90	18,0	25,0	22-3790	22-3791
39/70	20,0	30,0	22-3970	22-3971
39/80	20,0	30,0	22-3980	22-3981
39/90	20,0	30,0	22-3990	22-3991

Single lumen bronchial tube - left sided



- made of thermosensitive PVC, siliconised
- two delicate high volume low pressure cuffs
- smooth walls preventing gathering of secretion
- atraumatic, rounded tip and smooth cuff welding
- X-ray line along the tube
- stylet covered with medical plastic
- marked pilot balloons
- graduation mark
- 15 mm connector conforming to ISO 5356-1
- latex free, phthalate free
- sterile, single use

Set contains:

- bronchial tube, left sided
- 2 double swivel elbow connectors
- 4 control valve suction catheters

size I.D. [mm]	\varnothing_b cuff [mm]	\varnothing_1 cuff [mm]	reference number	
			left-sided tube	set
6,5	18,0	25,0	21-6510	21-6520
7,0	18,0	28,0	21-7010	21-7020
7,5	18,0	28,0	21-7510	21-7520
8,0	20,0	30,0	21-8010	21-8020
8,5	20,0	30,0	21-8510	21-8520

Single lumen bronchial tube - right sided



- made of thermosensitive PVC, siliconised
- two delicate high volume low pressure cuffs
- smooth walls preventing gathering of secretion
- atraumatic, rounded tip and smooth cuff welding
- X-ray line along the tube
- stylet covered with medical plastic
- marked pilot balloons
- graduation mark
- 15 mm connector conforming to ISO 5356-1
- latex free, phthalate free
- sterile, single use

Set contains:

- bronchial tube, right sided
- 2 double swivel elbow connectors
- 4 control valve suction catheters

size I.D. [mm]	\varnothing_b cuff [mm]	\varnothing_1 cuff [mm]	reference number	
			right-sided tube	set
6,5	18,0	25,0	22-6510	22-6520
7,0	18,0	28,0	22-7010	22-7020
7,5	18,0	28,0	22-7510	22-7520
8,0	20,0	30,0	22-8010	22-8020
8,5	20,0	30,0	22-8510	22-8520

Bronchial tube connectors set



- transparent extension tubes
- two swivel elbow connectors with soft seal and double port
- connector Y 15 mm
- sterile, single use

reference number
19-0100

Bronchial tube connectors set with clamps



- transparent extension tubes
- two swivel elbow connectors with soft seal and double port
- connector Y 15 mm
- clamps on each arm
- sterile, single use

type	reference number
single swivel	19-0101
double swivel	19-0102

Y connector



- parallel wye connector
- 2 x 15F patient connections
- 1 x 15M tubing connection
- no ports

reference number
19-0110

Silicone laryngeal mask, reusable



- made of medical grade silicone
- transparent tube and soft silicone cuff
- anatomic shape for easy, gentle insertion and optimal placement
- size, weight and cuff volume indicated on tube
- 15 mm connector
- reusable up to 40 times
- latex free, phthalate free
- sterile

size	patient weight [kg]	cuff volume [ml]	reference number
1,0	0-5	4	42-1000
1,5	5-10	7	42-1500
2,0	10-20	10	42-2000
2,5	20-30	14	42-2500
3,0	30-50	20	42-3000
4,0	50-70	30	42-4000
5,0	70-100	40	42-5000

Silicone laryngeal mask, single use



- made of medical grade silicone
- transparent tube and soft silicone cuff
- anatomic shape for easy, gentle insertion and optimal placement
- size, weight and cuff volume indicated on tube
- colour coded
- 15 mm connector
- latex free, phthalate free
- sterile, single use

size	colour	patient weight [kg]	cuff volume [ml]	reference number	
				standard	reinforced
1,0		0-5	4	42-1010	42-1012
1,5		5-10	7	42-1510	42-1512
2,0		10-20	10	42-2010	42-2012
2,5		20-30	14	42-2510	42-2512
3,0		30-50	20	42-3010	42-3012
4,0		50-70	30	42-4010	42-4012
5,0		70-100	40	42-5010	42-5012

Available in set with syringe and lubricating jelly under reference number with „J” at the end, for example „42-4010J.”

Laryngeal mask, single use



- made of medical grade PVC
- transparent tube and soft cuff
- anatomic shape for easy, gentle insertion and optimal placement
- size, weight and cuff volume indicated on tube
- colour coded
- 15 mm connector
- latex free, phthalate free
- sterile, single use

size	colour	patient weight [kg]	cuff volume [ml]	reference number
1,0		0-5	4	42-1050
1,5		5-10	7	42-1550
2,0		10-20	10	42-2050
2,5		20-30	14	42-2550
3,0		30-50	20	42-3050
4,0		50-70	30	42-4050
5,0		70-100	40	42-5050

Available in set with syringe and lubricating jelly under reference number with „J” at the end, for example „42-4050J.”

Nasopharyngeal airway

- made of thermosensitive PVC
- safeguard to avoid tuck into the epipharynx
- siliconised
- latex free, phthalate free
- sterile, single use

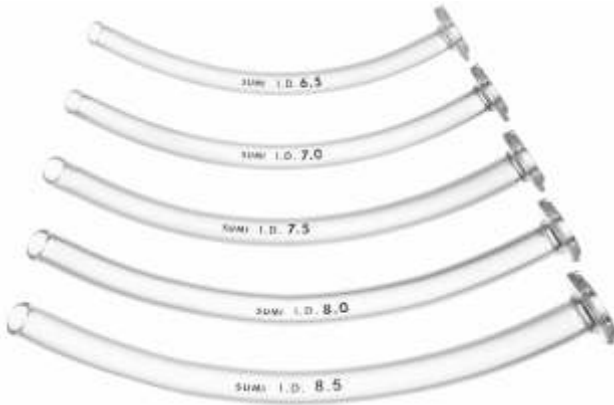

size I.D. [mm]	O.D. [mm]	reference number
2,5	3,5	41-2500
3,0	4,2	41-3000
3,5	4,8	41-3500
4,0	5,4	41-4000
4,5	6,0	41-4500
5,0	6,9	41-5000
5,5	7,5	41-5500
6,0	8,2	41-6000
6,5	9,4	41-6500
7,0	9,6	41-7000
7,5	10,3	41-7500
8,0	11,0	41-8000
8,5	11,7	41-8500
9,0	12,3	41-9000

Guedel airway

- made of medical PVC
- colour coded bite-blocks
- smoothly rounded edges
- integrated bite-block
- individually packed
- latex free, phthalate free
- sterile, single use



size	colour	length [mm]	reference number
000		30	40-1003
000		40	40-1004
00		50	40-1005
0		60	40-1006
1		70	40-1107
2		80	40-1208
2		90	40-1209
3		100	40-1310
4		110	40-1411
6		120	40-1612

Tracheal intubation stylet

- metal alloy covered with medical plastic
- soft tip
- latex free, phthalate free
- sterile, single use



size O.D. [mm]	length [mm]	reference number	for tubes size I.D. [mm]
1,9	230	09-1923	2,0 ÷ 3,0
2,0	230	09-2023	2,5 ÷ 3,0
2,2	230	09-2223	2,5 ÷ 3,5
3,0	340	09-3034	3,5 ÷ 5,0
4,0	340	09-4034	5,0 ÷ 8,0
4,0	600	09-4060	5,0 ÷ 8,0
5,0	370	09-5037	6,0 ÷ 11,0
5,0	600	09-5060	6,0 ÷ 11,0

Tracheal tube guide

- flexible reinforcement along the guide
- marked at each cm
- straight tip
- single use or reusable
- supplied inside a rigid pack
- latex free
- sterile

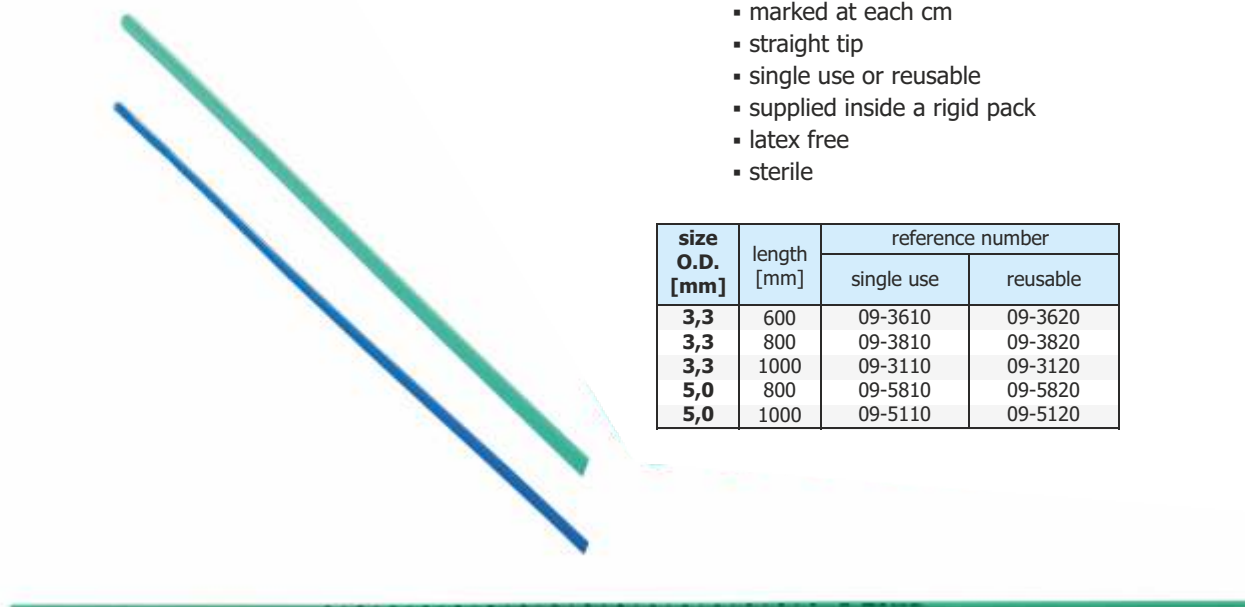

size O.D. [mm]	length [mm]	reference number	
		single use	reusable
3,3	600	09-3610	09-3620
3,3	800	09-3810	09-3820
3,3	1000	09-3110	09-3120
5,0	800	09-5810	09-5820
5,0	1000	09-5110	09-5120

Tracheal tube introducer

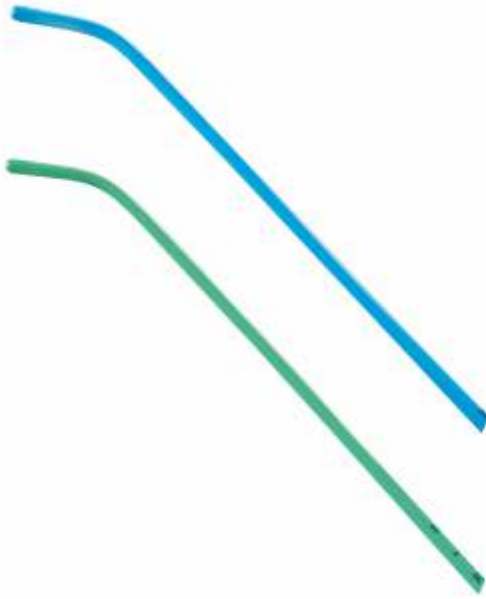

- "Bougie" type introducer
- flexible reinforcement
- graduation mark at each cm
- angled tip for ease of intubation
- made of plastic facilitating easy insertion and withdrawal
- single use or reusable
- supplied inside a rigid pack
- latex free
- sterile

size O.D. [mm]	length [mm]	reference number	
		single use	reusable
3,3	600	09-3617	09-3627
3,3	700	09-3717	09-3727
3,3	800	09-3817	09-3827
3,3	1000	09-3117	09-3127
5,0	600	09-5617	09-5627
5,0	700	09-5717	09-5727
5,0	800	09-5817	09-5827
5,0	1000	09-5117	09-5127



Tracheal tube introducer for infants

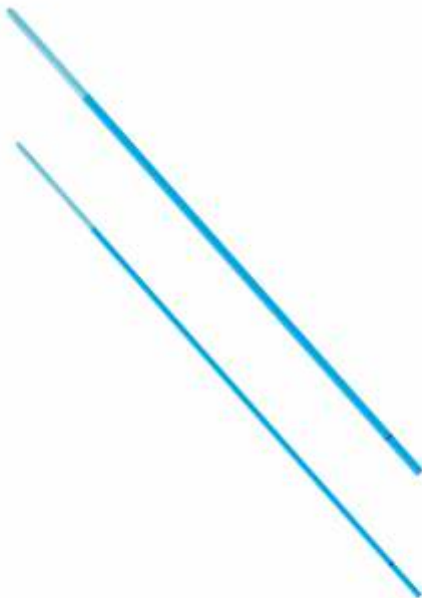

- flexible introducer
- straight distal tip made of soft, elastic material that eliminates the risk of delicate tissue damage
- depth graduation mark
- available in two diameters: 1,6 mm and 2,0 mm
- designated for tubes size 2,0; 2,5; 3,0
- latex free, phthalate free
- sterile, single use

size O.D. [mm]	length [mm]	reference number
1,6	600	09-1610
2,0	600	09-2010

Tracheal tube guide with ventilation lumen

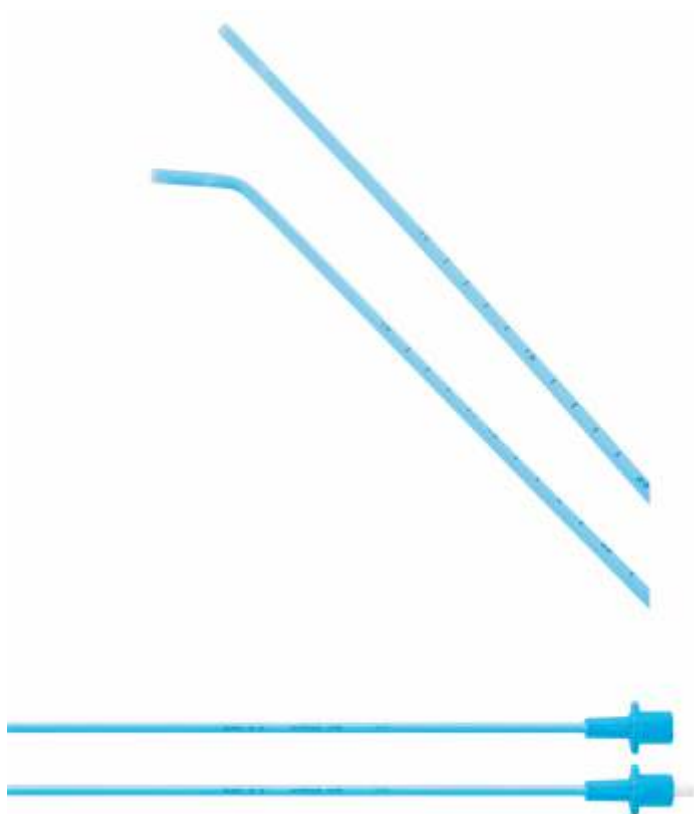

- flexible reinforcement along the guide
- with inner lumen for oxygenation during intubation and tube exchange
- in set with 15 mm connector: with or without Luer-Lock
- available straight or angled tip
- latex free, phthalate free
- sterile, single use

size O.D. [mm]	length [mm]	I.D. [mm]	reference number	
			straight tip	angled tip
2,6	600	1,2	09-2610	-
3,3	830	1,7	09-3910	09-3917
5,0	830	2,6	09-5910	09-5917
6,0	830	3,0	09-6910	09-6917

Bite blocks for tracheal tubes



- designated for fixation on tracheal tubes
- soft material protects teeth from damage
- protects tube from accidental biting
- available in 4 sizes, depending on tracheal tube size
- colour coded
- handle for easier manipulation
- latex free
- single use

tracheal tubes size (mm)	colour	reference number
6,0 - 6,5		19-6065
7,0 - 7,5		19-7075
8,0 - 8,5		19-8085
9,0 - 9,5		19-9095

Tracheal tube holder, two-piece



- laminated hook and loop fastener for sure grip
- adjustable for different neck size
- ultra soft material to avoid skin irritation
- hypoallergenic, latex free

Set contains:

- neck band
- 3 tube holders

size	reference number
for adult	19-0001

Tracheal tube holder, one-piece

New



- one-piece design
- length: 87 cm
- soft material preventing ulcers
- laminated hook and loop fastener for sure grip
- latex free

Set components:

- 10 one-piece tube holders
- 10 tracheal tube fixations

size	reference number
universal	19-0002

Disconnecting wedge

- facilitates easy disconnection of tracheal and tracheostomy tube from breathing circuits
- prevents tear on tube during disconnection



size	reference number
universal	19-0006

Extendible catheter mount with double swivel elbow connector

- double swivel elbow connector
- extendible, shape memorising
- compatible with tracheal tubes and other equipment
- connectors 22F – 22M/15F
- dead space volume 20-50 ml
- length 8-13 cm
- sterile, single use



reference number
19-1110

Extendible catheter mount with double swivel elbow connector and double port

- double swivel elbow connector
- extendible, shape memorising
- compatible with tracheal tubes and other equipment
- with double port for suctioning and bronchoscope
- connectors 22F – 22M/15F
- dead space volume 20-50 ml
- length 8-13 cm
- sterile, single use



reference number
19-1120

Corrugated catheter mount with double swivel elbow connector



- double swivel elbow connector
- corrugated
- compatible with tracheal tubes and other equipment
- connectors 22F – 22M/15F
- dead space volume 42 ml
- length 15 cm
- sterile, single use

reference number

19-2110

Corrugated catheter mount with double swivel elbow connector and double port



- double swivel elbow connector
- corrugated
- compatible with tracheal tubes and other equipment
- with double port for suctioning and bronchoscope
- connectors 22F – 22M/15F
- dead space volume 42 ml
- length 15 cm
- sterile, single use

reference number

19-2120

Corrugated catheter mount, straight



- corrugated
- compatible with tracheal tubes and other equipment
- connectors 15M – 22M/15F
- dead space volume 35 ml
- length 15 cm
- sterile, single use

reference number

19-2201

Smooth bore catheter mount with double swivel elbow connector and double port



- double swivel elbow connector
- smooth bore with anti-kinking reinforcement
- compatible with tracheal tubes and other equipment
- with double port for suctioning and bronchoscope
- connectors 22F – 22M/15F
- dead space volume 35 ml
- length 15 cm
- sterile, single use

reference number

19-3120

Smooth bore catheter mount with double swivel elbow connector and double port



- double swivel elbow connector
- smooth bore with anti-kinking reinforcement
- compatible with tracheal tubes and other equipment
- with double port for suctioning and bronchoscope
- connectors 15M – 22M/15F
- dead space volume 35 ml
- length 15 cm
- sterile, single use

reference number

19-3220

Smooth bore catheter mount, straight



- smooth bore with anti-kinking reinforcement
- compatible with tracheal tubes and other equipment
- connectors 15M – 22M/15F
- dead space volume 31 ml
- length 15 cm
- sterile, single use

reference number

19-3200

Double swivel elbow connector

- double port for suctioning and bronchoscope
- swivels 360°
- sterile, single use

22M/15F



15M

22M/15F



15M

type	reference number
without port	19-0201
with port	19-0200

Tracheal tube connector set

- 15 mm connectors made of plastic
- pack includes 16 pieces
- size from 2,5 to 10,0 mm, steps 0,5 mm
- non-sterile



reference number
19-0000

Silicone corrugated breathing tube

- reusable, autoclavable
- non-sterile
- medical grade silicone
- individually packed



size	length [mm]	reference number
connector 22 mm/22 mm	300	18-2030
	600	18-2060
	800	18-2080
	900	18-2090
	1200	18-2120
	1500	18-2150
connector 10 mm/10 mm	600	18-1060
	850	18-1085
	1100	18-1110
connector 10 mm/22 mm	450	18-3045
	600	18-3060
	850	18-3085

Closed suction system 72h

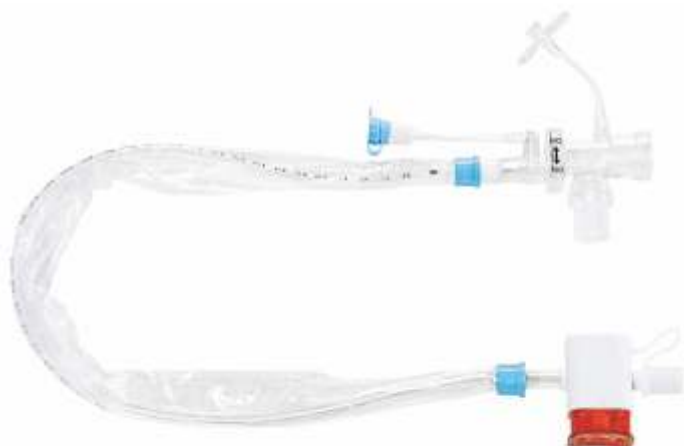

- mechanical push block system, sealing off access to the patient
- double swivel elbow connector
- MDI port for quick and effective drug delivery
- one-way valve for catheter rinsing
- transparent and durable sleeve securing suction catheter
- catheter with clearly visible graduation and rounded tip to minimize the risk of trachea mucosa damaging
- double black markings of catheter withdrawal
- colour coded sizes of suction catheter
- suction control button with built-in locking system to prevent accidental pressing
- sterile, phthalate free, latex free

Set includes

- closed suction catheter
- extendible tube
- disconnecting wedge
- day sticker

size [CH/FG]	colour	tracheal		tracheostomy	
		length [mm]	reference	length [mm]	reference
10	Black	540	73-1071	360	74-1071
12	White	540	73-1271	360	74-1271
14	Green	540	73-1471	360	74-1471
16	Orange	540	73-1671	360	74-1671
18	Red	540	73-1871	360	74-1871

Closed suction system 24h



- double swivel elbow connector
- MDI port for quick and effective drug delivery
- one-way valve for catheter rinsing
- catheter with clearly visible graduation and rounded tip to minimize the risk of trachea mucosa damaging
- transparent and durable sleeve securing suction catheter
- double black markings of catheter withdrawal
- colour coded sizes of suction catheter
- suction control button with built-in locking system to prevent accidental pressing
- sterile, phthalate free, latex free

Set includes

- closed suction catheter
- extendible tube
- disconnecting wedge
- day sticker

size [CH/FG]	colour	tracheal	
		length [mm]	reference
10	Black	540	73-1023
12	White	540	73-1223
14	Green	540	73-1423
16	Orange	540	73-1623
18	Red	540	73-1823

Closed suction system 72h, paediatric



- mechanical push block system, sealing off access to the patient
- MDI port for quick and effective drug delivery
- one-way valve for catheter rinsing
- transparent and durable sleeve securing suction catheter
- catheter with clearly visible graduation and rounded tip to minimize the risk of trachea mucosa damaging
- colour coded sizes of suction catheter
- double black markings of catheter withdrawal
- sterile, phthalate free, latex free

Set includes

- closed suction catheter
- connectors for different tube size
- day sticker

size [CH/FG]	colour	length [mm]	reference
5	grey	320	75-0572
6	yellow-green	320	75-0672
7	purple	320	75-0772
8	blue	360	75-0872
10	black	415	75-1072

Closed suction system 24h, paediatric



- MDI port for quick and effective drug delivery
- one-way valve for catheter rinsing
- catheter with clearly visible graduation and rounded tip to minimize the risk of trachea mucosa damaging
- transparent and durable sleeve securing suction catheter
- double black markings of catheter withdrawal
- colour coded sizes of suction catheter
- suction control button with built-in locking system to prevent accidental pressing
- sterile, phthalate free, latex free

Set includes

- closed suction catheter
- connectors for different tube size
- day sticker



size [CH/FG]	colour	length [mm]	reference
5	grey	320	75-0520
6	yellow-green	320	75-0620
7	purple	320	75-0720
8	blue	360	75-0820
10	black	415	75-1020

Tracheostomy tubes

Tracheostomy tubes are significant part of SUMI production.

We offer comprehensive range of sophisticated tracheostomy product which meet different patient needs. Introduced and maintained high quality standards, workmanship, proper design of SUMI tubes ensures safety of use and confidence for both clinician and patient.

Tracheostomy tubes are produced from best thermosensitive medical PVC, latex free and phthalate free. These properties of polymer provide patient comfort – adapting to patient airway shape and minimize risk of allergic reactions and other complications.

Main features of SUMI tracheostomy tubes:

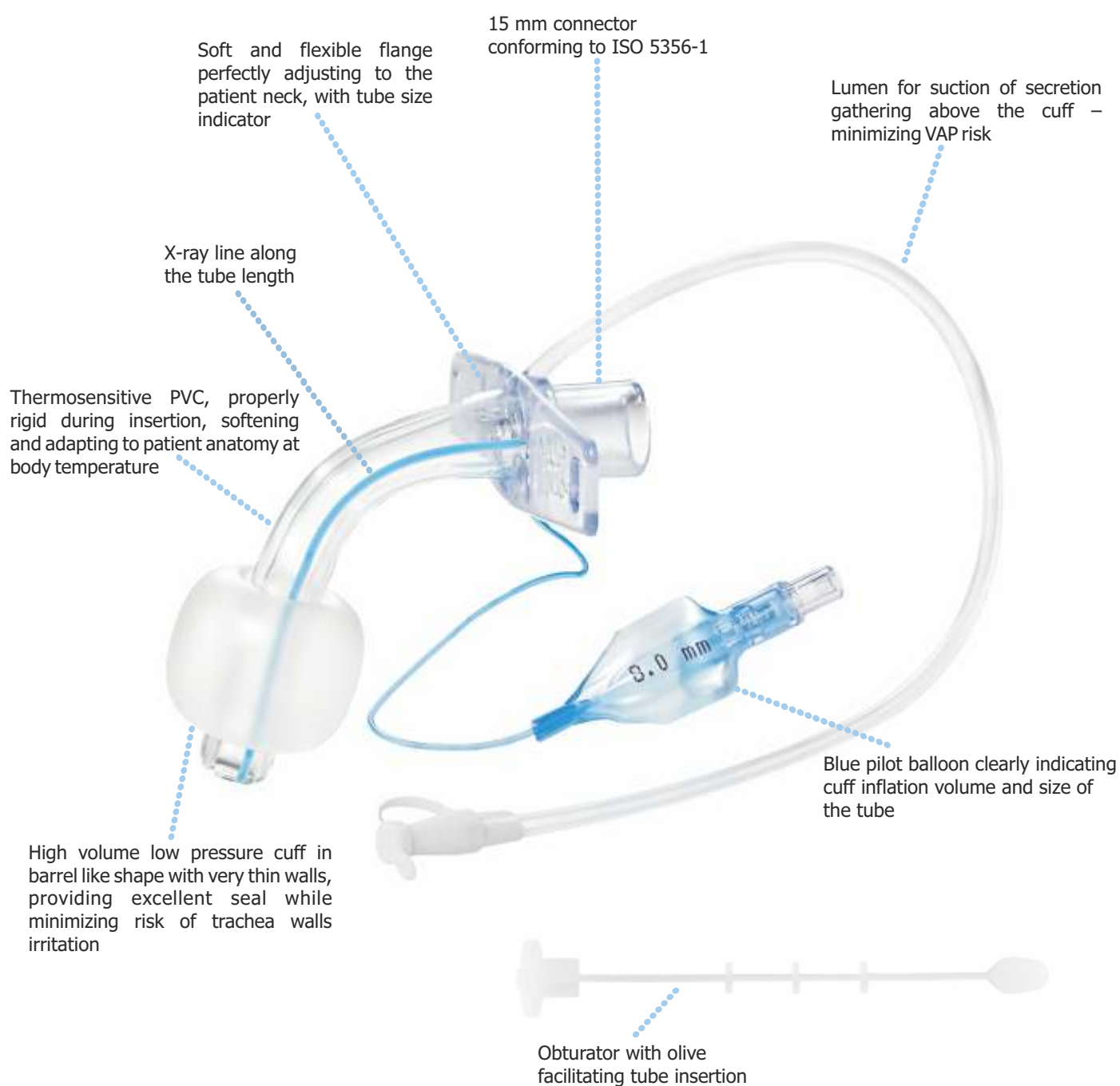

Tracheostomy tubes

SUMI experience in manufacturing resulted in reliable, high quality products, in variety of types and sizes. Offer includes following products, all siliconised:

- tracheostomy tubes with cuff - fixed or adjustable flange, different shapes and lengths
- tubes with fenestration holes, facilitate speaking
- tracheostomy tubes with double cuff, help to prevent tracheal trauma
- tubes without cuff for both children and adults
- reinforced tracheostomy tubes with or without cuff, accurately flexible while maintaining extraordinary kinking resistance
- tracheostomy tubes with suction lumen, to prevent risk of VAP

We can also manufacture custom made tubes with individual dimensions.

Tracheostomy tube without cuff, with cuff, siliconised 31-XX00, 31-XX10, 31-XX55, 33-XX00, 33-XX10, 33-XX51, 33-XX52, 33-XX53, 34-XX10, 39-XX41						
I.D. [mm]	O.D. [mm]	A [mm]	B [mm]	C [mm]	L [mm]	C.D. [mm]
3,0	4,2	15	3	17	35	9
3,5	4,8	15	4	18	37	10
4,0	5,4	16	4	20	40	12
4,5	6,0	21	4	21	46	12
5,0	6,9	23	2	23	48	15
5,5	7,5	24	2	24	50	15
6,0	8,2	25	2	32	59	18
6,5	8,9	26	2	34	62	18
7,0	9,7	27	4	37	68	22
7,5	10,3	30	6	38	74	22
8,0	11,0	32	10	40	82	26
8,5	11,7	34	10	40	84	26
9,0	12,3	36	17	40	93	30
9,5	13,0	38	18	41	97	30
10,0	13,7	38	18	42	98	32

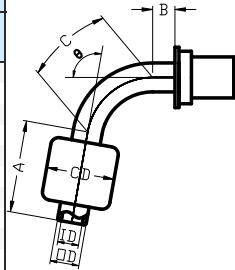

Tracheostomy tube with adjustable flange, reinforced 35-XX10, 36-XX10, 37-XX10, 38-XX10, 39-XX11						
I.D. [mm]	O.D. [mm]	A [mm]	B _{max} [mm]	C [mm]	L _{max} [mm]	C.D. [mm]
5,0	6,9	23	12	23	58	15
5,5	7,5	24	14	24	62	15
6,0	8,2	25	15	32	72	18
6,5	8,9	26	17	34	77	18
7,0	9,7	27	21	37	85	22
7,5	10,3	30	25	38	93	22
8,0	11,0	32	26	40	98	26
8,5	11,7	34	28	40	102	26
9,0	12,3	36	29	40	105	30
9,5	13,0	38	31	41	110	30
10,0	13,7	38	31	42	111	32
11,0	14,8	39	31	42	112	34

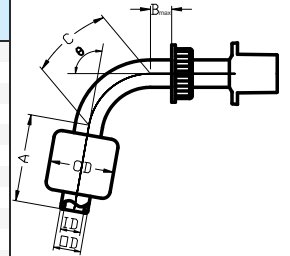

Tracheostomy tube with double cuff, siliconised 32-XX10						
I.D. [mm]	O.D. [mm]	A [mm]	B [mm]	C [mm]	L [mm]	C.D. [mm]
5,0	6,9	33	2	23	58	15
6,0	8,2	33	2	32	67	15
6,5	8,9	33	2	34	69	18
7,0	9,7	38	4	37	79	18
7,5	10,3	38	6	38	82	22
8,0	11,0	42	10	40	92	22
8,5	11,7	42	10	40	92	25
9,0	12,3	50	17	40	107	25
9,5	13,0	50	18	41	109	25
10,0	13,7	55	18	42	115	29

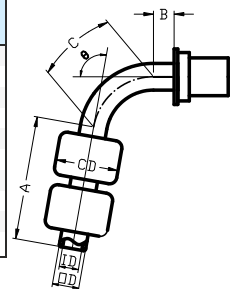

Tracheostomy tube with double cuff and adjustable flange, siliconised 32-XX40						
I.D. [mm]	O.D. [mm]	A [mm]	B _{max} [mm]	C [mm]	L _{max} [mm]	C.D. [mm]
5,0	6,9	33	12	23	68	15
6,0	8,2	33	15	32	80	15
6,5	8,9	33	16	34	83	18
7,0	9,7	38	24	37	99	18
7,5	10,3	38	30	38	106	22
8,0	11,0	42	31	40	113	22
8,5	11,7	42	34	40	116	25
9,0	12,3	50	28	40	118	25
9,5	13,0	50	29	41	120	25
10,0	13,7	55	29	42	126	29

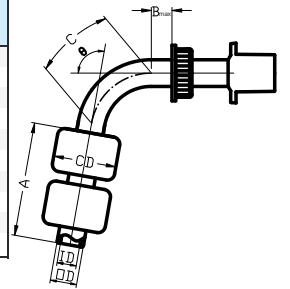

- A – distal length
 B – proximal length
 B_{max} – max. proximal length
 C – radial length
 L – total tube length, A+C+B
 L_{max} – max. effective total tube length A+C+B_{max}

- θ – bending angle 100°
 I.D. – internal diameter
 O.D. – outer diameter
 C.D. – cuff diameter

Tracheostomy tube with high volume low pressure cuff



- made of thermosensitive PVC, siliconised
- high volume low pressure cuff
- with or without fenestration
- X-ray line
- soft, smooth, transparent flange
- obturator
- 2 neck tapes
- marked pilot balloon
- latex free, phthalate free
- sterile, single use

size I.D. [mm]	O.D. [mm]	length L [mm]	reference number	
			standard	fenestrated
3,0	4,2	35	31-3010	-
3,5	4,8	37	31-3510	-
4,0	5,4	40	31-4010	-
4,5	6,0	46	31-4510	-
5,0	6,9	48	31-5010	31-5055
5,5	7,5	50	31-5510	31-5555
6,0	8,2	59	31-6010	31-6055
6,5	8,9	62	31-6510	31-6555
7,0	9,7	68	31-7010	31-7055
7,5	10,3	74	31-7510	31-7555
8,0	11,0	82	31-8010	31-8055
8,5	11,7	84	31-8510	31-8555
9,0	12,3	93	31-9010	31-9055
9,5	13,0	97	31-9510	31-9555
10,0	13,7	98	31-1010	31-1055

Tracheostomy tube with double cuff



- made of thermosensitive PVC, siliconised
- two low pressure cuffs
- X-ray line
- soft, smooth, transparent flange - fixed or adjustable
- obturator
- 2 neck tapes
- marked pilot balloon
- latex free, phthalate free
- sterile, single use

size I.D. [mm]	O.D. [mm]	reference number		reference number	
		length L [mm]	with fixed flange	length L _{max} [mm]	with adjustable flange
5,0	6,9	58	32-5010	68	32-5040
6,0	8,2	67	32-6010	80	32-6040
7,0	9,7	79	32-7010	99	32-7040
7,5	10,3	82	32-7510	106	32-7540
8,0	11,0	92	32-8010	113	32-8040
8,5	11,7	92	32-8510	116	32-8540
9,0	12,3	107	32-9010	118	32-9040
9,5	13,0	109	32-9510	120	32-9540
10,0	13,7	115	32-1010	126	32-1040

Tracheostomy tube without cuff



- made of thermosensitive PVC, siliconised
- X-ray line
- soft, smooth, transparent flange
- obturator in tube with connector
- 2 neck tapes
- latex free, phthalate free
- sterile, single use

size I.D. [mm]	O.D. [mm]	length L [mm]	reference number	
			with connector	without connector
3,0	4,2	35	33-3010	34-3010
3,5	4,8	37	33-3510	34-3510
4,0	5,4	40	33-4010	34-4010
4,5	6,0	46	33-4510	34-4510
5,0	6,9	48	33-5010	34-5010
5,5	7,5	50	33-5510	34-5510
6,0	8,2	59	33-6010	34-6010
6,5	8,9	62	33-6510	34-6510
7,0	9,7	68	33-7010	34-7010
7,5	10,3	74	33-7510	34-7510
8,0	11,0	82	33-8010	34-8010
8,5	11,7	84	33-8510	34-8510
9,0	12,3	93	33-9010	34-9010
9,5	13,0	97	33-9510	34-9510
10,0	13,7	98	33-1010	34-1010

Tracheostomy tube without cuff, fenestrated



- made of thermosensitive PVC, siliconised
- fenestrated
- X-ray line
- soft, smooth, transparent flange
- obturator
- 2 neck tapes
- latex free, phthalate free
- sterile, single use

size I.D. [mm]	O.D. [mm]	length L [mm]	reference number		
			1 hole	2 holes	5 holes
3,0	4,2	35	33-3051	33-3052	33-3055
3,5	4,8	37	33-3551	33-3552	33-3555
4,0	5,4	40	33-4051	33-4052	33-4055
4,5	6,0	46	33-4551	33-4552	33-4555
5,0	6,9	48	33-5051	33-5052	33-5055
5,5	7,5	50	33-5551	33-5552	33-5555
6,0	8,2	59	33-6051	33-6052	33-6055
6,5	8,9	62	33-6551	33-6552	33-6555
7,0	9,7	68	33-7051	33-7052	33-7055
7,5	10,3	74	33-7551	33-7552	33-7555
8,0	11,0	82	33-8051	33-8052	33-8055
8,5	11,7	84	33-8551	33-8552	33-8555
9,0	12,3	93	33-9051	33-9052	33-9055
9,5	13,0	97	33-9551	33-9552	33-9555
10,0	13,7	98	33-1051	33-1052	33-1055

Tracheostomy tube with adjustable flange



- adjustable flange facilitate tube length adjustment
- made of thermosensitive PVC, siliconised
- with high volume low pressure cuff or without cuff
- X-ray line
- soft, smooth, transparent, adjustable flange
- obturator
- 2 neck tapes
- marked pilot balloon
- graduation mark
- latex free, phthalate free
- sterile, single use



size I.D. [mm]	O.D. [mm]	length L _{max} [mm]	reference number	
			with cuff	without cuff
5,0	6,9	58	35-5010	36-5010
5,5	7,5	62	35-5510	36-5510
6,0	8,2	72	35-6010	36-6010
6,5	8,9	76	35-6510	36-6510
7,0	9,7	84	35-7010	36-7010
7,5	10,3	92	35-7510	36-7510
8,0	11,0	97	35-8010	36-8010
8,5	11,7	102	35-8510	36-8510
9,0	12,3	104	35-9010	36-9010
9,5	13,0	109	35-9510	36-9510
10,0	13,7	110	35-1010	36-1010
11,0	14,8	110	35-1110	36-1110

Tracheostomy tube with adjustable flange, long



- extended proximal and distal length
- adjustable flange facilitate tube length adjustment
- made of thermosensitive PVC, siliconised
- with high volume low pressure cuff or without cuff
- X-ray line
- soft, smooth, transparent, adjustable flange
- obturator
- 2 neck tapes
- marked pilot balloon
- graduation mark
- latex free, phthalate free
- sterile, single use



size I.D. [mm]	O.D. [mm]	length L _{max} [mm]	reference number	
			with cuff	without cuff
7,0	9,7	100	35-7017	36-7017
8,0	11,0	116	35-8017	36-8017
9,0	12,3	122	35-9017	36-9017
10,0	13,7	128	35-1017	36-1017

Reinforced tracheostomy tube with adjustable flange



- adjustable flange facilitate tube length adjustment
- made of thermosensitive PVC, siliconised
- with high volume low pressure cuff or without cuff
- reinforcement made of stainless steel, kink-resistant
- soft, smooth, transparent, adjustable flange
- obturator
- 2 neck tapes
- marked pilot balloon
- graduation mark
- latex free, phthalate free
- sterile, single use

size I.D. [mm]	O.D. [mm]	length L _{max} [mm]	reference number	
			with cuff	without cuff
5,0	6,9	58	37-5010	38-5010
5,5	7,5	62	37-5510	38-5510
6,0	8,2	72	37-6010	38-6010
6,5	8,9	76	37-6510	38-6510
7,0	9,7	84	37-7010	38-7010
7,5	10,3	92	37-7510	38-7510
8,0	11,0	97	37-8010	38-8010
8,5	11,7	102	37-8510	38-8510
9,0	12,3	104	37-9010	38-9010
9,5	13,0	109	37-9510	38-9510
10,0	13,7	110	37-1010	38-1010
11,0	14,8	110	37-1110	38-1110

Reinforced tracheostomy tube with adjustable flange, long



- extended proximal and distal length
- adjustable flange facilitate tube length adjustment
- made of thermosensitive PVC, siliconised
- with high volume low pressure cuff or without cuff
- reinforcement made of stainless steel, kink-resistant
- soft, smooth, transparent, adjustable flange
- obturator
- 2 neck tapes
- marked pilot balloon
- graduation mark
- latex free, phthalate free
- sterile, single use

size I.D. [mm]	O.D. [mm]	length L _{max} [mm]	reference number	
			with cuff	without cuff
7,0	9,7	100	37-7017	38-7017
8,0	11,0	116	37-8017	38-8017
9,0	12,3	122	37-9017	38-9017
10,0	13,7	128	37-1017	38-1017

Reinforced tracheostomy tube, straight



- flexible for better adjustment to patient trachea
- straight and long, non-preformed
- adjustable flange facilitate tube length adjustment
- made of thermosensitive PVC, siliconised
- with high volume low pressure cuff or without cuff
- reinforcement made of stainless steel, kink-resistant
- soft, smooth, transparent, adjustable flange
- obturator
- 2 neck tapes
- marked pilot balloon
- graduation mark
- latex free, phthalate free
- sterile, single use

size I.D. [mm]	O.D. [mm]	length [mm]	reference number	
			with cuff	without cuff
7,0	9,7	100	37-7018	38-7018
8,0	11,0	116	37-8018	38-8018
9,0	12,3	122	37-9018	38-9018
10,0	13,7	128	37-1018	38-1018

Reinforced tracheostomy tube, extra long, arced

New



- flexible for better adjustment to patient trachea
- extra long, arced
- adjustable flange facilitate tube length adjustment
- made of thermosensitive PVC, siliconised
- with high volume low pressure cuff or without cuff
- reinforcement made of stainless steel, kink-resistant
- soft, smooth, transparent, adjustable flange
- obturator
- 2 neck tapes
- marked pilot balloon
- graduation mark
- latex free, phthalate free
- sterile, single use

size I.D. [mm]	O.D. [mm]	length L _{max} [mm]	reference number	
			with cuff	without cuff
6,0	8,2	155	37-6020	38-6020
7,0	9,7	155	37-7020	38-7020
7,5	10,3	155	37-7520	38-7520
8,0	11,0	155	37-8020	38-8020
8,5	11,7	155	37-8520	38-8520
9,0	12,3	155	37-9020	38-9020
9,5	13,0	155	37-9520	38-9520
10,0	13,7	155	37-1020	38-1020
10,5	14,2	155	37-1520	38-1520
11,0	14,8	155	37-1120	38-1120

Tracheostomy tube with suction lumen



- made of thermosensitive PVC, siliconised
- very useful for long-term ventilation
- allows suctioning of secretions from above the cuff
- suction lumen ended with universal connector
- high volume low pressure cuff
- X-ray line
- soft, smooth, transparent flange - fixed or adjustable
- obturator
- 2 neck tapes
- marked pilot balloon
- latex free, phthalate free
- sterile, single use

size I.D. [mm]	O.D. [mm]	reference number		reference number	
		length L [mm]	fixed flange	length L _{max} [mm]	adjustable flange
5,0	6,9	48	39-5041	58	39-5011
5,5	7,5	50	39-5541	62	39-5511
6,0	8,2	59	39-6041	72	39-6011
6,5	8,9	62	39-6541	77	39-6511
7,0	9,7	68	39-7041	85	39-7011
7,5	10,3	74	39-7541	93	39-7511
8,0	11,0	82	39-8041	98	39-8011
8,5	11,7	84	39-8541	102	39-8511
9,0	12,3	93	39-9041	105	39-9011
9,5	13,0	97	39-9541	110	39-9511
10,0	13,7	98	39-1041	111	39-1011

Montandon type tube



- made of thermosensitive PVC, siliconised
- special shape for tracheostomy intubation
- high volume low pressure cuff
- X-ray line
- marked pilot balloon
- latex free, phthalate free
- sterile, single use

size I.D. [mm]	Ø cuff [mm]	non reinforced		reinforced	
		O.D. [mm]	ref.	O.D. [mm]	ref.
7,0	23,0	9,7	29-7010	10,2	29-7012
8,0	26,0	11,0	29-8010	11,6	29-8012
9,0	30,0	12,3	29-9010	12,9	29-9012
10,0	32,0	13,7	29-1010	14,2	29-1012

SUMINI tracheostomy tube

We present the highest quality tracheostomy tubes for children.

Line of SUMINI tracheostomy tubes is intended for newborn babies, infants and small children.

Tubes are designed and developed to fit their specific needs.

SUMINI are made of soft, flexible and thermosensitive medical grade Polymer, free of latex and DEHP.

Very soft and special shaped flange minimizes pressure on patient neck and at the same time prevents skin from injury.

SUMINI tracheostomy tubes are available in 2 versions: for neonates and paediatric. The main difference between them is size of flange and length of tube.

Both versions are suitable for long term mechanical ventilation.

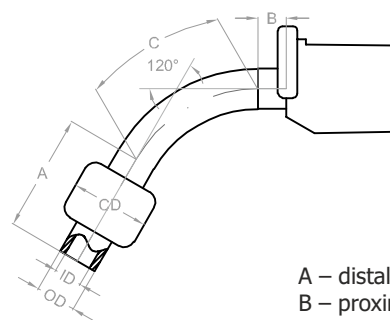
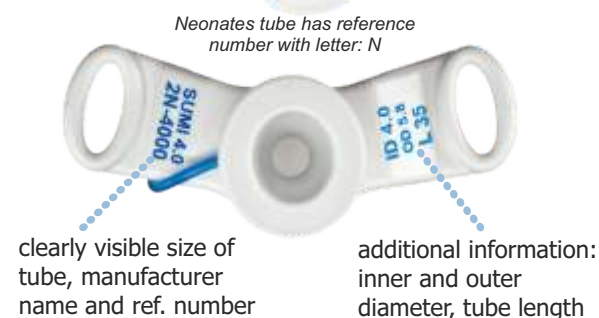
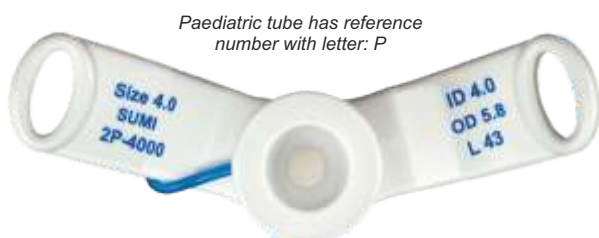
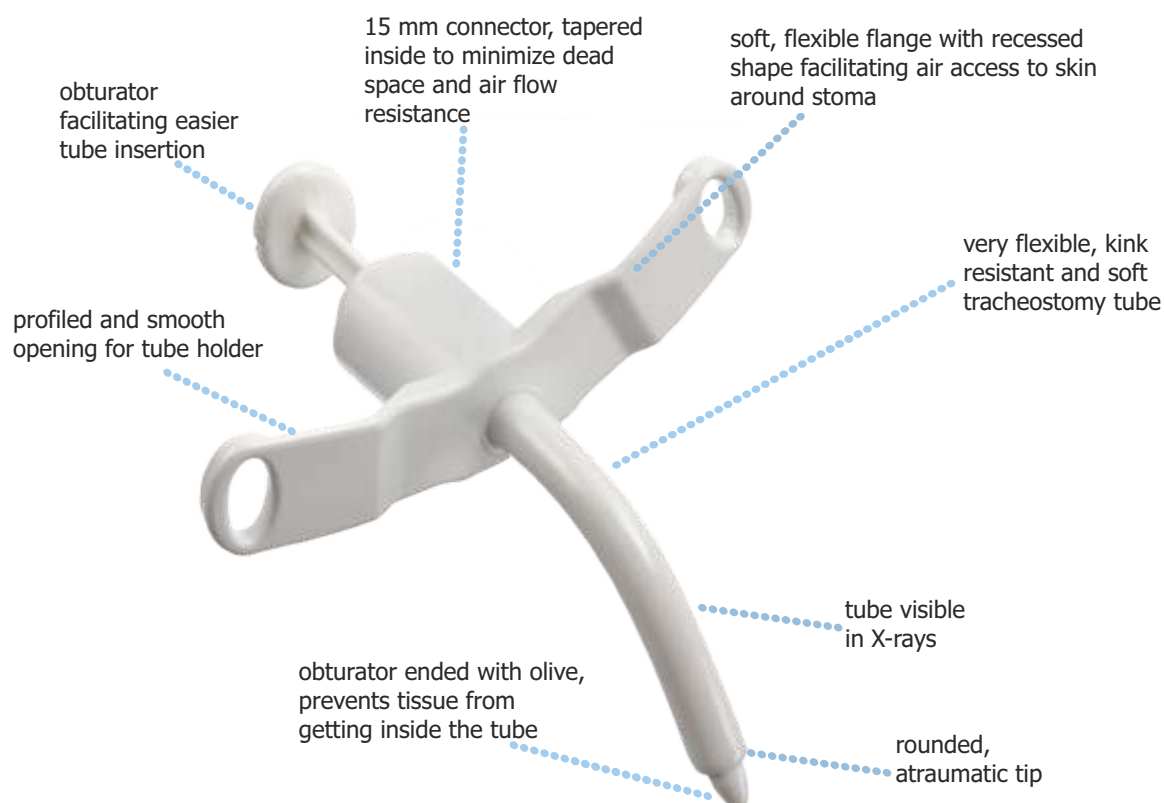

- A – distal length
- B – proximal length
- C – radial length
- L - total length = A+C+B
- I.D. – internal diameter
- O.D. – outer diameter
- C.D. – cuff diameter

SUMINI paediatric tracheostomy tube with cuff

New



- made of highest quality medical material, flexible and adapting to patient anatomy
- high volume low pressure cuff
- soft, flexible and special shaped flange facilitate firm fastening and minimizes skin irritation
- perfectly matched obturator
- neck tape for fastening
- visible in X-rays
- rounded, atraumatic tip
- latex free, phthalate free
- sterile, single use

size I.D. [mm]	O.D. [mm]	length L [mm]	Ø cuff [mm]	reference number
2,5	4,0	32	8,0	2P-2500
3,0	4,5	35	9,0	2P-3000
3,5	5,1	39	10,0	2P-3500
4,0	5,8	43	12,0	2P-4000
4,5	6,5	47	12,0	2P-4500
5,0	7,1	49	15,0	2P-5000
5,5	7,6	54	15,0	2P-5500
6,0	8,3	60	18,0	2P-6000

SUMINI paediatric tracheostomy tube without cuff

New



- made of highest quality medical material, flexible and adapting to patient anatomy
- soft, flexible and special shaped flange facilitate firm fastening and minimizes skin irritation
- perfectly matched obturator
- neck tape for fastening
- visible in X-rays
- rounded, atraumatic tip
- latex free, phthalate free
- sterile, single use

size I.D. [mm]	O.D. [mm]	length L [mm]	reference number
2,5	4,0	32	3P-2500
3,0	4,5	35	3P-3000
3,5	5,1	39	3P-3500
4,0	5,8	43	3P-4000
4,5	6,5	47	3P-4500
5,0	7,1	49	3P-5000
5,5	7,6	54	3P-5500
6,0	8,3	60	3P-6000

SUMINI neonate tracheostomy tube with cuff

New



- made of highest quality medical material, flexible and adapting to patient anatomy
- high volume low pressure cuff
- soft, flexible and special shaped flange facilitate firm fastening and minimizes skin irritation
- perfectly matched obturator
- neck tape for fastening
- visible in X-rays
- rounded, atraumatic tip
- latex free, phthalate free
- sterile, single use

size I.D. [mm]	O.D. [mm]	length L [mm]	Ø cuff [mm]	reference number
2,5	4,0	30	8,0	2N-2500
3,0	4,5	31	9,0	2N-3000
3,5	5,1	33	10,0	2N-3500
4,0	5,8	35	12,0	2N-4000

SUMINI neonate tracheostomy tube without cuff

New



- made of highest quality medical material, flexible and adapting to patient anatomy
- soft, flexible and special shaped flange facilitate firm fastening and minimizes skin irritation
- perfectly matched obturator
- neck tape for fastening
- visible in X-rays
- rounded, atraumatic tip
- latex free, phthalate free
- sterile, single use

size I.D. [mm]	O.D. [mm]	length L [mm]	reference number
2,5	4,0	30	3N-2500
3,0	4,5	31	3N-3000
3,5	5,1	33	3N-3500
4,0	5,8	35	3N-4000

SUMI presents high quality KAN tracheostomy tubes with changeable inner cannulas

KAN tracheostomy tubes, offered in wide range of types can be used in many health facilities: hospitals (laryngology and intensive care units), hospices, medical care facilities as well as home care.

KAN tubes are recommended for long - term tracheostomy. They are made of highest quality thermosensitive PVC, right shaped to best fit patient anatomy.

The most important feature of KAN tubes are reusable inner cannulas, which may be removed for cleaning or change, without necessity of outer tube removal.

Tubes range is complemented by many useful accessories, supplied in set.

Features of KAN tubes :

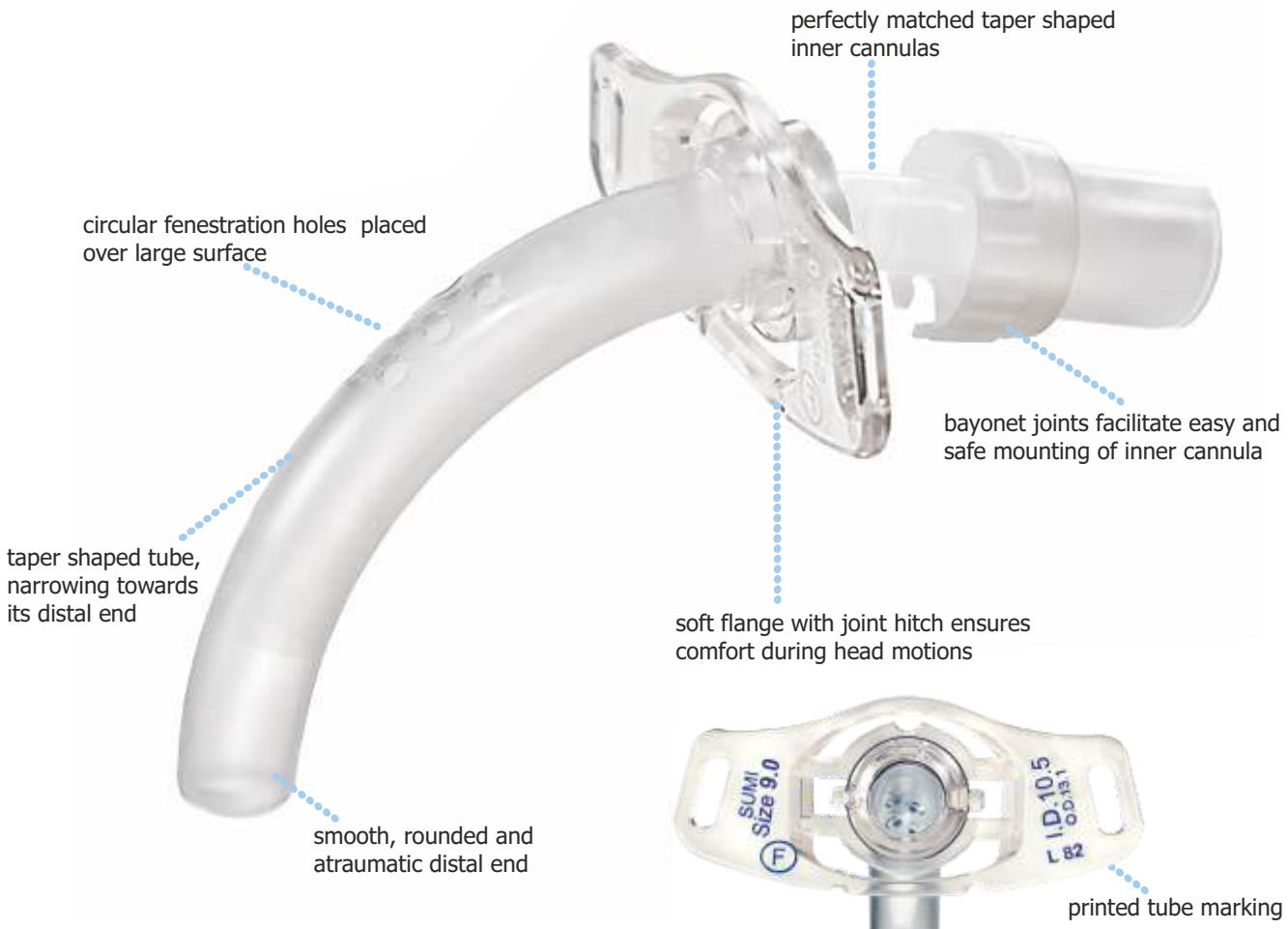

KAN tubes dimensions :

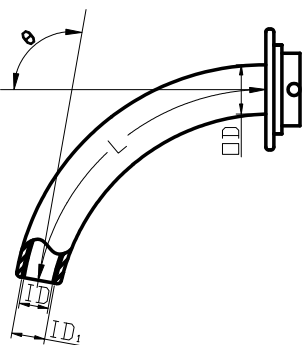

- I.D. - cannula inside diameter / size [mm]
- I.D.₁ - tube inside diameter [mm]
- O.D. - tube outside diameter [mm]
- C.D. - cuff diameter [mm]
- L - tube length [mm]
- θ° - bending angle [°]

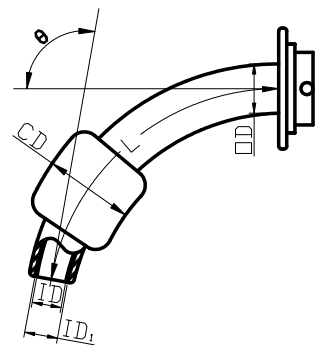

KAN tracheostomy tube without cuff

Set I

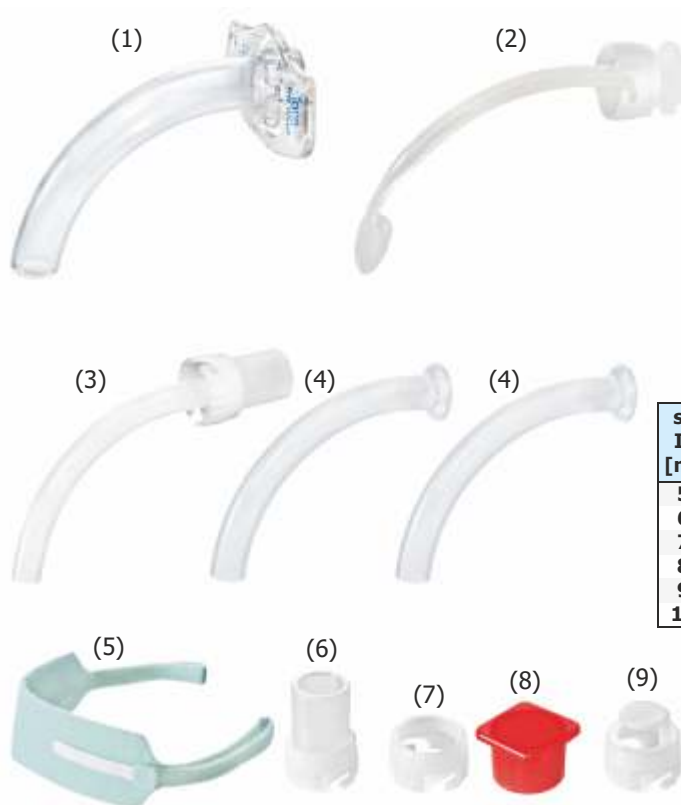

Set components:

- KAN tube without cuff (1)
- obturator (2)
- 1 inner cannula with 15 mm connector (3)
- 2 inner cannulas with collar (4)
- soft tracheostomy tube holder (5)
- 15 mm connector (6)
- connecting plug (7)
- decannulation cap (8)
- protective plug (9)

size I.D. [mm]	colour	tube O.D. [mm]	cannula I.D. [mm]	length L [mm]	tube I.D. ₁ [mm]	bending angle Θ [°]	ref.
5,0	Yellow	9,1	5,0	62	6,5	115	47-5000
6,0	Orange	10,2	6,0	70	7,5	110	47-6000
7,0	Green	11,2	7,0	72	8,5	105	47-7000
8,0	White	12,2	8,0	80	9,5	100	47-8000
9,0	Blue	13,1	9,0	82	10,5	95	47-9000
10,0	Yellow	14,3	10,0	84	11,5	90	47-1000

- KAN tube made of thermosensitive PVC
- perfectly matched transparent tube and inner cannulas
- soft flanges with joint hitch
- bayonet joint
- colour coded
- facilitates cleaning and disinfection of cannulas
- obturator
- phthalate free, latex free
- sterile

KAN tracheostomy tube without cuff

Set II

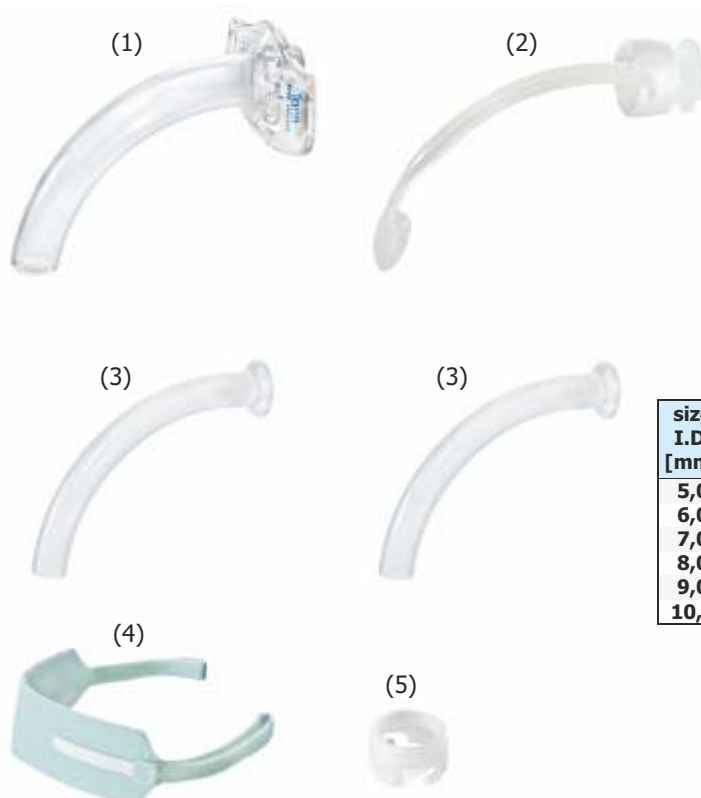

Set components:

- KAN tube without cuff (1)
- obturator (2)
- 2 inner cannulas with collar (3)
- soft tracheostomy tube holder (4)
- connecting plug (5)

size I.D. [mm]	colour	tube O.D. [mm]	cannula I.D. [mm]	length L [mm]	tube I.D. ₁ [mm]	bending angle Θ [°]	ref.
5,0	Yellow	9,1	5,0	62	6,5	115	47-5001
6,0	Orange	10,2	6,0	70	7,5	110	47-6001
7,0	Green	11,2	7,0	72	8,5	105	47-7001
8,0	White	12,2	8,0	80	9,5	100	47-8001
9,0	Blue	13,1	9,0	82	10,5	95	47-9001
10,0	Yellow	14,3	10,0	84	11,5	90	47-1001

KAN tracheostomy tube without cuff, fenestrated

Set I

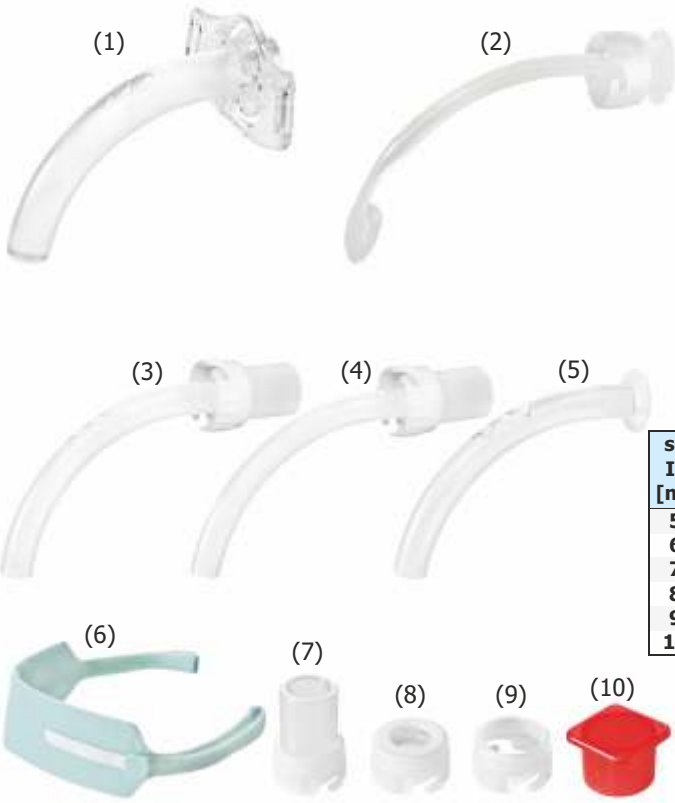

Set components:

- KAN tube without cuff, fenestrated (1)
- obturator (2)
- 1 inner cannula with 15 mm connector fenestrated (3)
- 1 inner cannula with 15 mm connector, non-fenestrated (4)
- 1 inner cannula with collar, fenestrated (5)
- soft tracheostomy tube holder (6)
- 15 mm connector (7)
- speaking valve (8)
- connecting plug (9)
- decannulation cap (10)
- protective plug (11)

size I.D. [mm]	colour	tube O.D. [mm]	cannula I.D. [mm]	length L [mm]	tube I.D. ₁ [mm]	bending angle Θ [°]	ref.
5,0	Yellow	9,1	5,0	62	6,5	115	47-5010
6,0	Orange	10,2	6,0	70	7,5	110	47-6010
7,0	Green	11,2	7,0	72	8,5	105	47-7010
8,0	White	12,2	8,0	80	9,5	100	47-8010
9,0	Blue	13,1	9,0	82	10,5	95	47-9010
10,0	Yellow	14,3	10,0	84	11,5	90	47-1010

- KAN tube made of thermosensitive PVC
- perfectly matched transparent tube and inner cannulas
- concentric fenestrated holes
- soft flanges with joint hitch
- bayonet joint
- colour coded
- facilitates cleaning and disinfection of cannulas
- obturator
- phthalate free, latex free
- sterile

KAN tracheostomy tube without cuff, fenestrated

Set II

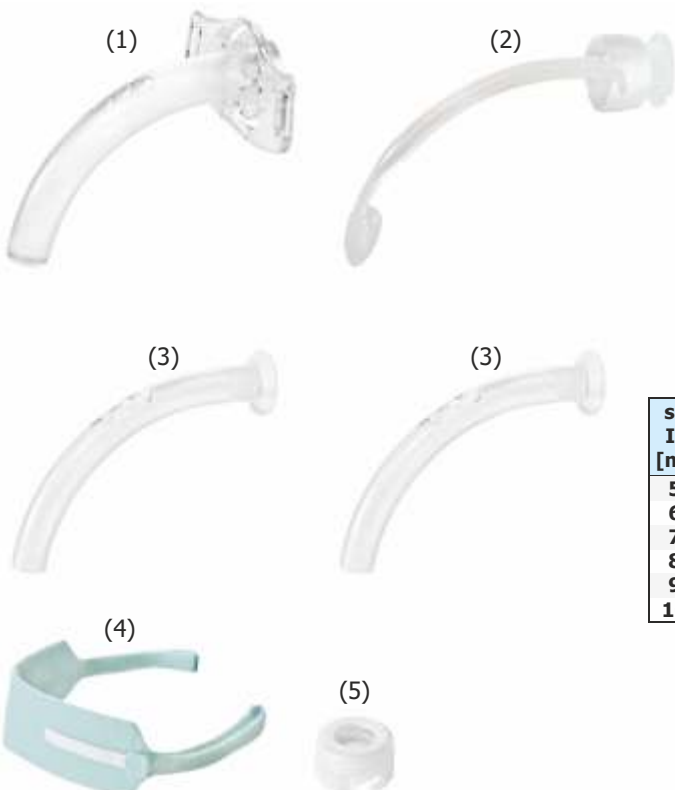

Set components:

- KAN tube without cuff, fenestrated (1)
- obturator (2)
- 2 inner cannulas with collar, fenestrated (3)
- soft tracheostomy tube holder (4)
- speaking valve (5)

size I.D. [mm]	colour	tube O.D. [mm]	cannula I.D. [mm]	length L [mm]	tube I.D. ₁ [mm]	bending angle Θ [°]	ref.
5,0	Yellow	9,1	5,0	62	6,5	115	47-5011
6,0	Orange	10,2	6,0	70	7,5	110	47-6011
7,0	Green	11,2	7,0	72	8,5	105	47-7011
8,0	White	12,2	8,0	80	9,5	100	47-8011
9,0	Blue	13,1	9,0	82	10,5	95	47-9011
10,0	Yellow	14,3	10,0	84	11,5	90	47-1011

KAN tracheostomy tube with cuff

Set I



Set components:

- KAN tube with cuff (1)
- obturator (2)
- 2 inner cannulas with 15 mm connector (3)
- 1 inner cannula with collar (4)
- soft tracheostomy tube holder (5)
- 15 mm connector (6)
- connecting plug (7)
- decannulation cap (8)
- protective plug (9)

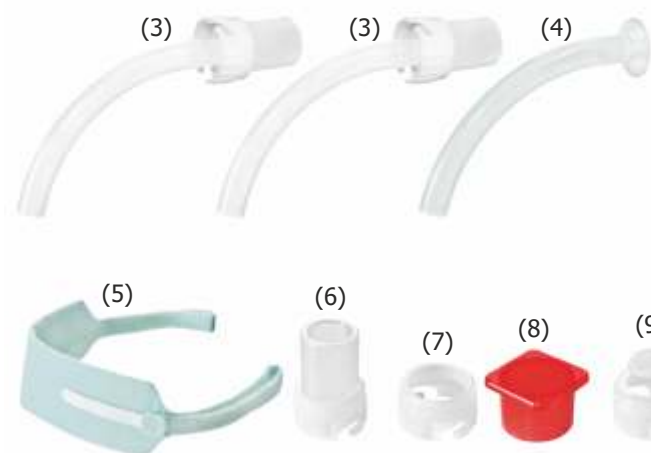

size I.D. [mm]	colour	tube O.D. [mm]	cannula I.D. [mm]	length L [mm]	tube I.D. ₁ [mm]	bending angle Θ [°]	ref.
5,0	Yellow	10,6	5,0	62	6,5	115	48-5000
6,0	Orange	11,7	6,0	70	7,5	110	48-6000
7,0	Green	12,8	7,0	72	8,5	105	48-7000
8,0	White	13,8	8,0	80	9,5	100	48-8000
9,0	Blue	14,8	9,0	82	10,5	95	48-9000
10,0	Yellow	15,8	10,0	84	11,5	90	48-1000

- KAN tube made of thermosensitive PVC
- perfectly matched transparent tube and inner cannulas
- high volume cylindrical-shape cuff with thin walls
- soft flanges with joint hitch
- bayonet joint
- colour coded
- facilitates cleaning and disinfection of cannulas
- obturator with perforation for Seldinger guide
- phthalate free, latex free
- sterile

KAN tracheostomy tube with cuff

Set II



Set components:

- KAN tube with cuff (1)
- obturator (2)
- 2 inner cannulas with 15 mm connector (3)
- soft tracheostomy tube holder (4)

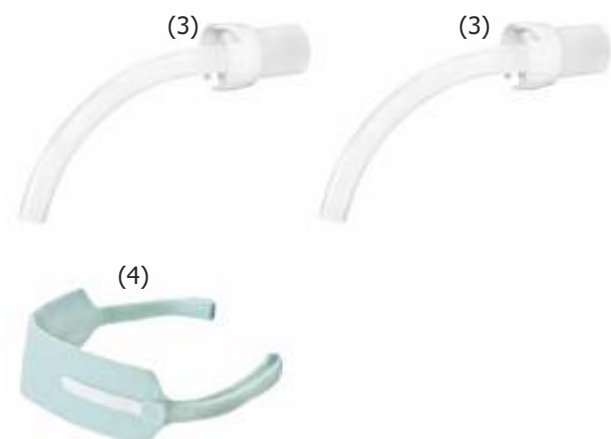

size I.D. [mm]	colour	tube O.D. [mm]	cannula I.D. [mm]	length L [mm]	tube I.D. ₁ [mm]	bending angle Θ [°]	ref.
5,0	Yellow	10,6	5,0	62	6,5	115	48-5001
6,0	Orange	11,7	6,0	70	7,5	110	48-6001
7,0	Green	12,8	7,0	72	8,5	105	48-7001
8,0	White	13,8	8,0	80	9,5	100	48-8001
9,0	Blue	14,8	9,0	82	10,5	95	48-9001
10,0	Yellow	15,8	10,0	84	11,5	90	48-1001

KAN tracheostomy tube with cuff, fenestrated

Set I



Set components:

- KAN tube with cuff, fenestrated (1)
- obturator (2)
- 1 inner cannula with 15 mm connector fenestrated (3)
- 1 inner cannula with 15 mm connector, non-fenestrated (4)
- 1 inner cannula with collar, fenestrated (5)
- soft tracheostomy tube holder (6)
- 15 mm connector (7)
- speaking valve (8)
- connecting plug (9)
- decannulation cap (10)
- protective plug (11)



size I.D. [mm]	colour	tube O.D. [mm]	cannula I.D. [mm]	length L [mm]	tube I.D. ₁ [mm]	bending angle Θ [°]	ref.
5,0	Yellow	10,6	5,0	62	6,5	115	48-5010
6,0	Orange	11,7	6,0	70	7,5	110	48-6010
7,0	Green	12,8	7,0	72	8,5	105	48-7010
8,0	White	13,8	8,0	80	9,5	100	48-8010
9,0	Blue	14,8	9,0	82	10,5	95	48-9010
10,0	Yellow	15,8	10,0	84	11,5	90	48-1010



- KAN tube made of thermosensitive PVC
- perfectly matched transparent tube and inner cannulas
- high volume cylindrical-shape cuff with thin walls
- concentric fenestrated holes
- soft flanges with joint hitch
- bayonet joint
- colour coded
- facilitates cleaning and disinfection of cannulas
- obturator with perforation for Seldinger guide
- phthalate free, latex free
- sterile

KAN tracheostomy tube with cuff, fenestrated

Set II



Set components:

- KAN tube with cuff (1)
- obturator (2)
- 2 inner cannulas with 15 mm connector (3)
- soft tracheostomy tube holder (4)



size I.D. [mm]	colour	tube O.D. [mm]	cannula I.D. [mm]	length L [mm]	tube I.D. ₁ [mm]	bending angle Θ [°]	ref.
5,0	Yellow	10,6	5,0	62	6,5	115	48-5011
6,0	Orange	11,7	6,0	70	7,5	110	48-6011
7,0	Green	12,8	7,0	72	8,5	105	48-7011
8,0	White	13,8	8,0	80	9,5	100	48-8011
9,0	Blue	14,8	9,0	82	10,5	95	48-9011
10,0	Yellow	15,8	10,0	84	11,5	90	48-1011



KAN laryngectomy tube

Set I



Set components:

- KAN tube short (1)
- obturator (2)
- 1 inner cannula with 15 mm connector (3)
- 2 inner cannulas with collar (4)
- soft tracheostomy tube holder (5)
- 15 mm connector (6)
- connecting plug (7)
- protective plug (8)

size I.D. [mm]	colour	tube O.D. [mm]	cannula I.D. [mm]	length L [mm]	tube I.D. ₁ [mm]	bending angle Θ [°]	ref.
5,0	Yellow	9,1	5,0	45	6,5	130	47-5020
6,0	Orange	10,2	6,0	47	7,5	130	47-6020
7,0	Green	11,2	7,0	49	8,5	125	47-7020
8,0	White	12,2	8,0	51	9,5	125	47-8020
9,0	Blue	13,1	9,0	53	10,5	120	47-9020
10,0	Yellow	14,3	10,0	55	11,5	120	47-1020

- KAN tube made of thermosensitive PVC
- short tube for stoma keeping
- perfectly matched transparent tube and inner cannulas
- soft flanges with joint hitch
- bayonet joint
- colour coded
- facilitates cleaning and disinfection of cannulas
- obturator
- phthalate free, latex free
- sterile

KAN laryngectomy tube

Set II

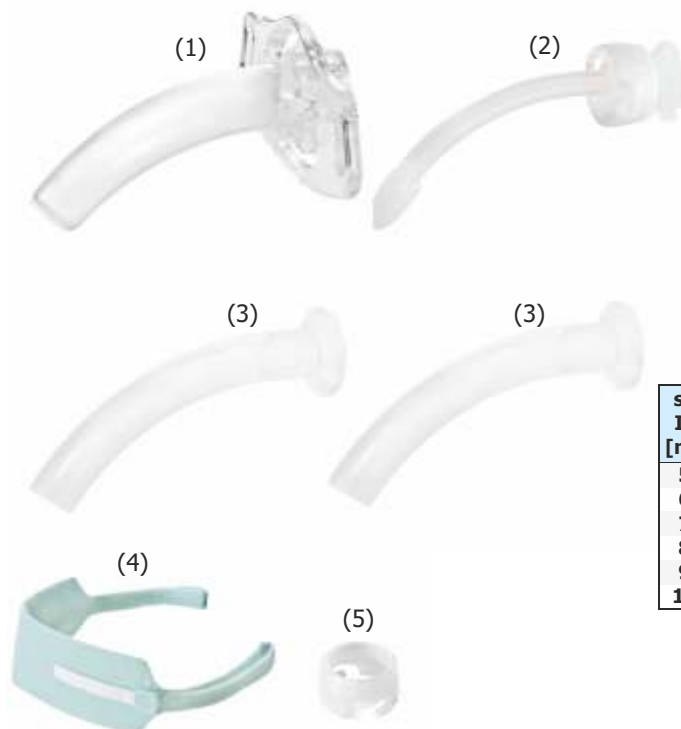

Set components:

- KAN tube short (1)
- obturator (2)
- 2 inner cannulas with collar (3)
- soft tracheostomy tube holder (4)
- connecting plug (5)

size I.D. [mm]	colour	tube O.D. [mm]	cannula I.D. [mm]	length L [mm]	tube I.D. ₁ [mm]	bending angle Θ [°]	ref.
5,0	Yellow	9,1	5,0	45	6,5	130	47-5021
6,0	Orange	10,2	6,0	47	7,5	130	47-6021
7,0	Green	11,2	7,0	49	8,5	125	47-7021
8,0	White	12,2	8,0	51	9,5	125	47-8021
9,0	Blue	13,1	9,0	53	10,5	120	47-9021
10,0	Yellow	14,3	10,0	55	11,5	120	47-1021

KAN laryngectomy tube, fenestrated

Set I

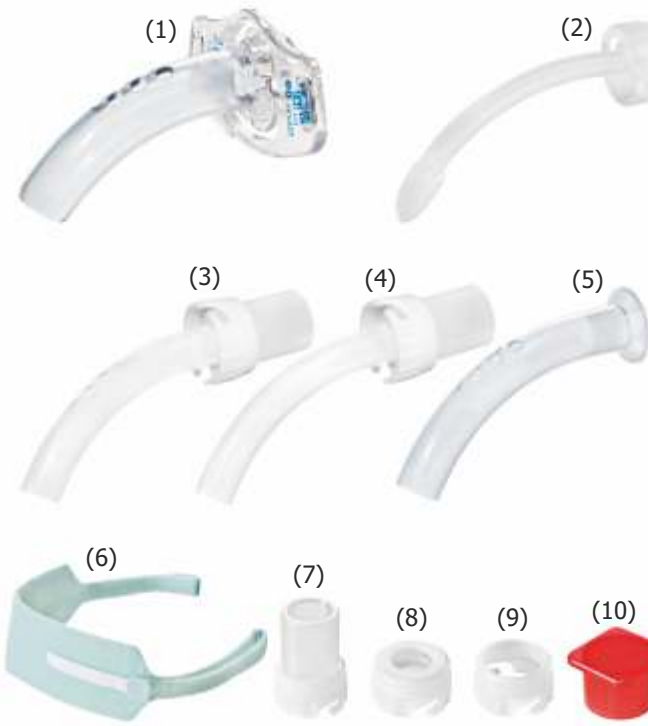

Set components:

- KAN tube short, fenestrated (1)
- obturator (2)
- 1 inner cannula with 15 mm connector, fenestrated (3)
- 1 inner cannula with 15 mm connector, non-fenestrated (4)
- 1 inner cannula with collar, fenestrated (5)
- soft tracheostomy tube holder (6)
- 15 mm connector (7)
- speaking valve (8)
- connecting plug (9)
- decannulation cap (10)
- protective plug (11)

size I.D. [mm]	colour	tube O.D. [mm]	cannula I.D. [mm]	length L [mm]	tube I.D. ₁ [mm]	bending angle Θ [°]	ref.
5,0	Yellow	9,1	5,0	45	6,5	130	47-5030
6,0	Orange	10,2	6,0	47	7,5	130	47-6030
7,0	Green	11,2	7,0	49	8,5	125	47-7030
8,0	White	12,2	8,0	51	9,5	125	47-8030
9,0	Blue	13,1	9,0	53	10,5	120	47-9030
10,0	Yellow	14,3	10,0	55	11,5	120	47-1030

- KAN tube made of thermosensitive PVC
- short tube for stoma keeping
- perfectly matched transparent tube and inner cannulas
- soft flanges with joint hitch
- bayonet joint
- colour coded
- facilitates cleaning and disinfection of cannulas
- obturator
- phthalate free, latex free
- sterile

KAN laryngectomy tube, fenestrated

Set II

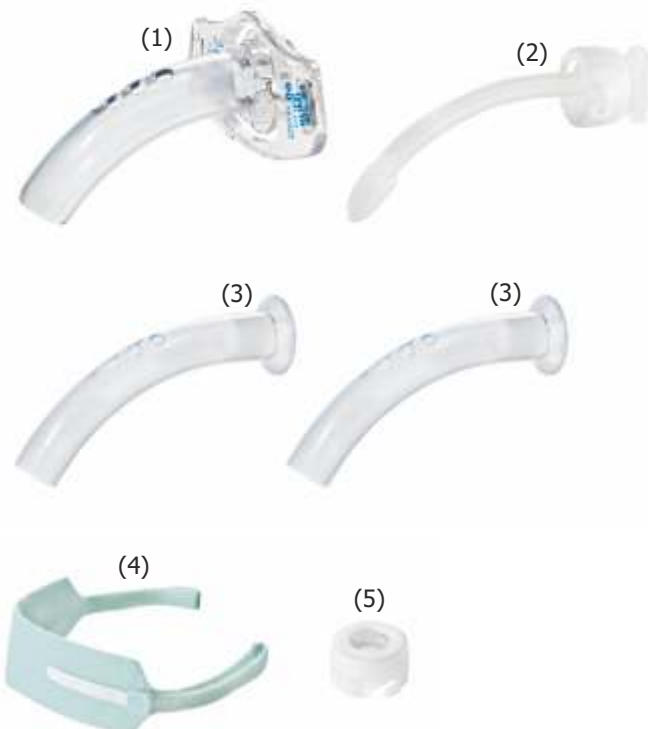

Set components:

- KAN tube short, fenestrated (1)
- obturator (2)
- 2 inner cannulas with collar, fenestrated (3)
- soft tracheostomy tube holder (4)
- speaking valve (5)

size I.D. [mm]	colour	tube O.D. [mm]	cannula I.D. [mm]	length L [mm]	tube I.D. ₁ [mm]	bending angle Θ [°]	ref.
5,0	Yellow	9,1	5,0	45	6,5	130	47-5031
6,0	Orange	10,2	6,0	47	7,5	130	47-6031
7,0	Green	11,2	7,0	49	8,5	125	47-7031
8,0	White	12,2	8,0	51	9,5	125	47-8031
9,0	Blue	13,1	9,0	53	10,5	120	47-9031
10,0	Yellow	14,3	10,0	55	11,5	120	47-1031

KAN tracheostomy tube with suction lumen

Set I

Set components:

- KAN tube with suction lumen (1)
- obturator (2)
- 2 inner cannulas with 15 mm connector (3)
- 1 inner cannula with collar (4)
- soft tracheostomy tube holder (5)
- 15 mm connector (6)
- connecting plug (7)
- decannulation cap (8)
- protective plug (9)

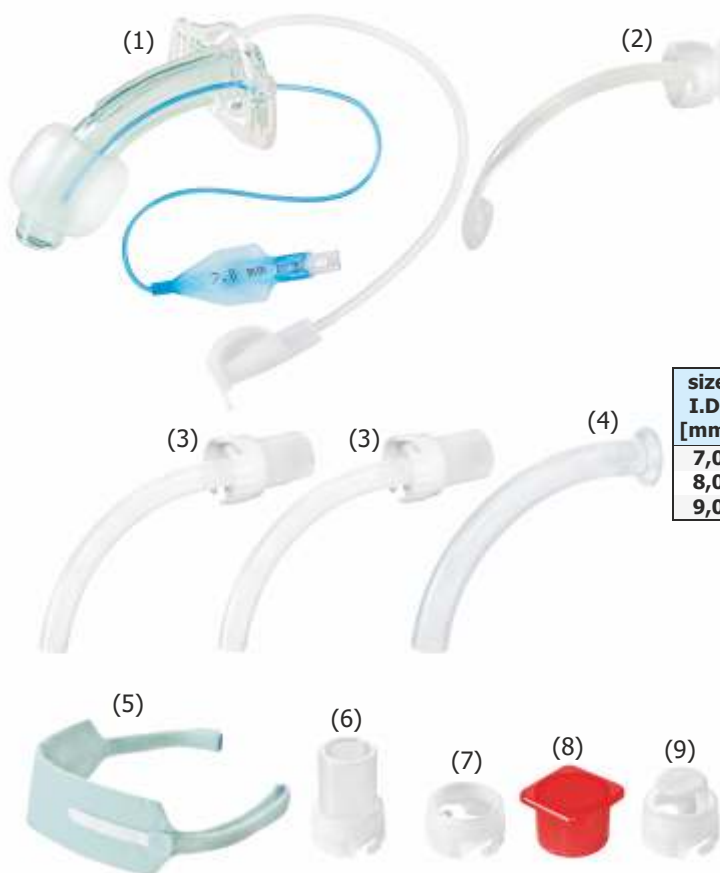

size I.D. [mm]	colour	tube O.D. [mm]	cannula I.D. [mm]	length L [mm]	tube I.D. ₁ [mm]	bending angle Θ [°]	ref.
7,0	green	12,8	7,0	72	8,5	105	49-7010
8,0	white	13,8	8,0	80	9,5	100	49-8010
9,0	blue	14,8	9,0	82	10,5	95	49-9010

- KAN tube made of thermosensitive PVC
- perfectly matched transparent tube and inner cannulas
- high volume cylindrical-shape cuff with thin walls
- soft flanges with joint hitch
- bayonet joint
- colour coded
- facilitates cleaning and disinfection of cannulas
- obturator with perforation for Seldinger guide
- phthalate free, latex free
- sterile

Tracheostomy tube holder



- one-piece design
- possibility of length adjustment
- skin-friendly, comfortable
- sterile, single use

ref.	type
45-0001	adults
45-0005	children

Tracheostomy tube holder



- two-pieces with stretchy section for patient comfort
- pleasantly soft, delicate and flexible
- non-sterile, single use

ref.	type
45-0002	adults
45-0003	children

Tracheostomy pad



- very soft and delicate
- prevents skin from irritation
- highly absorbent
- sterile, single use

ref.	type
45-0093	adults
45-0094	children

Heat and moisture exchanger "artificial nose"



- body made of medical plastic
- 2 paper filters
- oxygen port
- 15 mm connector
- available with connecting tube 16CH/2100 cm
- suction port
- latex free, phthalate free
- sterile, single use

ref.	type
45-0050	heat and moisture exchanger
45-0055	HME with oxygen connecting tube

Heat and moisture exchanger "artificial nose" MINI with bayonet connector



- body made of medical plastic
- filter made of PU foam
- oxygen port
- bayonet connector
- available with connecting tube 14CH/2100 cm
- latex free, phthalate free
- sterile, single use

ref.	type
45-0051	heat and moisture exchanger MINI
45-0057	HME with oxygen connecting tube

Heat and moisture exchanger "artificial nose" MINI



- body made of medical plastic
- filter made of PU foam
- oxygen port
- 15 mm connector
- available with connecting tube 14CH/2100 cm
- latex free, phthalate free
- sterile, single use

ref.	type
45-0053	heat and moisture exchanger MINI
45-0056	HME with oxygen connecting tube

KAN tracheostomy tube accessories



ref.	name
45-XX00	cannula with 15 mm connector, size 5-10



ref.	name
45-XX01	cannula with 15 mm connector fenestrated, size 5-10



ref.	name
45-XX10	cannula with collar, size 5-10



ref.	name
45-XX11	cannula with collar fenestrated, size 5-10



ref.	name
45-XX02	short cannula with 15 mm connector, size 5-10



ref.	name
45-XX03	short cannula with 15 mm connector fenestrated, size 5-10



ref.	name
45-XX12	short cannula with collar, size 5-10



ref.	name
45-XX13	short cannula with collar fenestrated, size 5-10



ref.	name
45-XX20	15 mm connector



ref.	name
45-0021	15 mm connector, universal size



ref.	name
45-0028	connecting plug



ref.	name
45-0030	speaking valve for bayonet connection
45-0031	speaking valve for 15mm connector

XX - stands for size of corresponding KAN tracheostomy tube

KAN tracheostomy tube accessories



ref.	name
45-0035	speaking valve with oxygen port



ref.	name
45-0040	decannulation cap



ref.	name
45-0041	decannulation plug



ref.	name
45-0045	protective plug



ref.	name
45-0004	neck strap



ref.	name
45-0052	laryngectomy filter



ref.	cleaning brush with handle
45-0662	size 6 mm
45-0862	size 8 mm
45-1262	size 12 mm



ref.	cleaning brush
45-1561	straight 15 mm
45-1563	angled 15 mm



ref.	name
45-0072	cleaning swabs large
45-0071	cleaning swabs small

Suction handles, tubing, catheters

SUMI Yankauer suction handles are used in operating rooms of general surgery, laryngology, neurology, urology, orthopedics, children surgery, facial-skull, thoracosurgery. They are characterized by high usage properties. Our flexibility allows us to offer standard products as well as custom made orders with parameters required at the moment. Available are just suction handles or in set with tubing, ready to use from the moment of opening the package, sterile, single use, in double packing.

Handles are made of rigid transparent material. They are perfectly smooth inside to minimize the flow resistance. Length range from 150 to 290 mm.

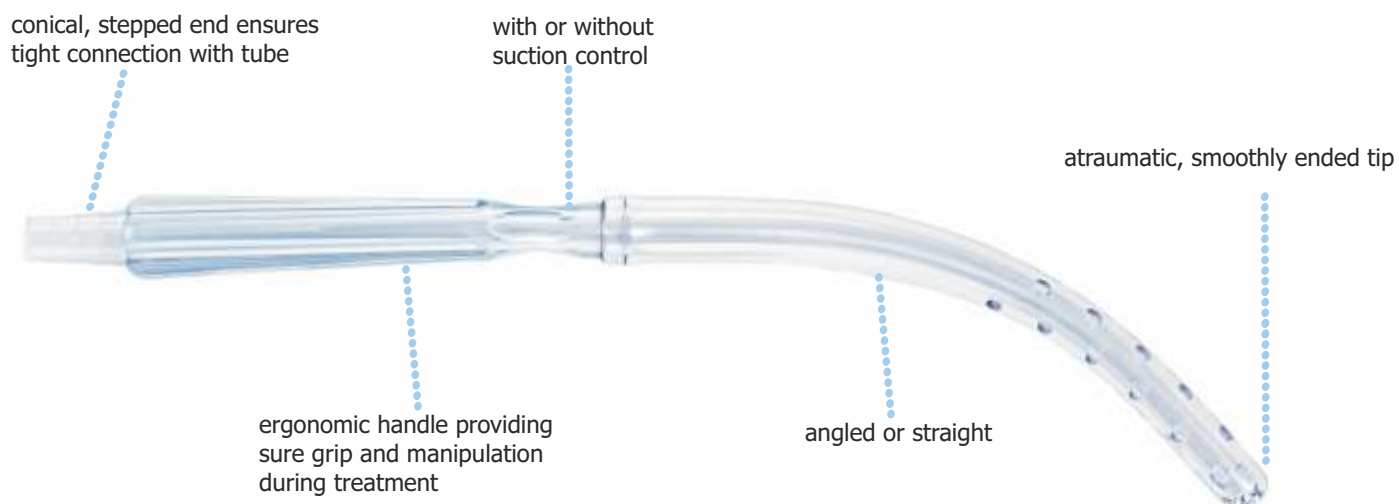

Tubing is flexible and has a kink-resistant protection ensured by reinforcing stripes along outer surface of tube. It is smooth inside to minimize the flow resistance. Available are many ending options allowing tight connection to each suctioning device: kink-resistant connector with or without cutting possibility, finger-tip or funnel, as well as straight ending without connectors.

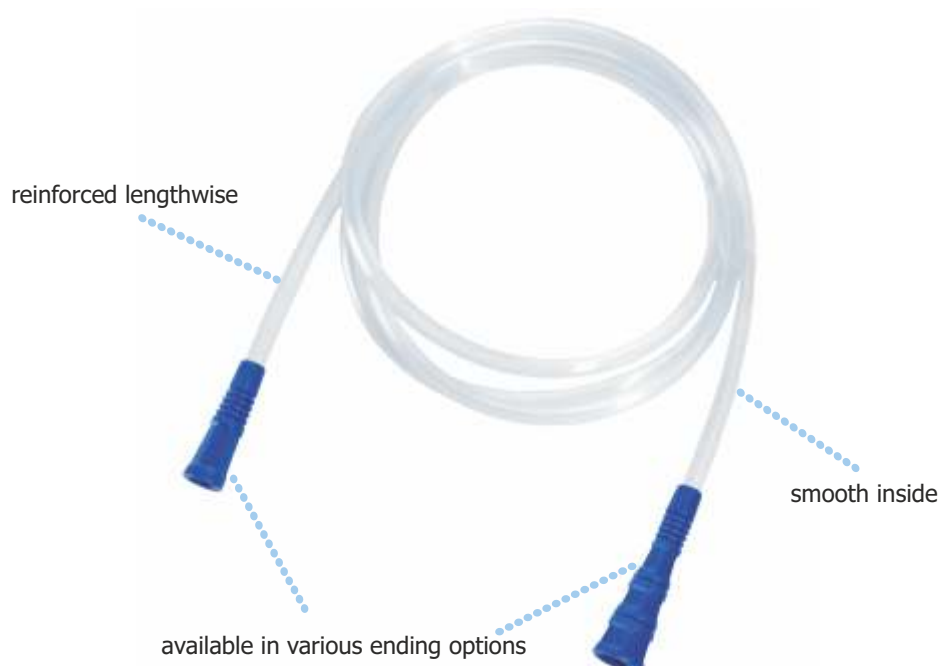

Suction handle with filter, set





- ergonomic handle
- replaceable filter inside the handle blocking bone chips, cement, mucus, etc.
- spare filter for exchange during a treatment
- 3 interchangeable tips: short, long angled, long straight
- available in set with connecting tube with anti-kinking connectors reinforced along its length
- recommended for use during treatments with large amount of debris, for e.g. orthopaedic, gynecologic
- made of transparent rigid material
- double packing
- sterile, single use

Set components:







- straight tip, 260 mm
- angled tip, 220 mm
- angled tip, 160 mm
- spare filter
- suction handle with pre-inserted filter

Set	suction handle with filters	set with tubing			
		25CH/2100 mm	25CH/3000 mm	30CH/2100 mm	30CH/3000 mm
ref.	77-5100	77-5220	77-5320	77-5230	77-5330







Suction handle Yankauer type

Type	Yankauer standard, angled	Yankauer standard, straight	Yankauer bulb tip, angled	Yankauer sump, angled
	without suction control			
with suction control	78-2100	78-2102	78-1100	78-0100
	78-2101	78-2103	78-1101	78-0101





Suction handle Yankauer type

Type	miniature short, 12CH, angled	miniature short, 12CH, straight	miniature short, 16CH, angled	miniature short, 16CH, straight	miniature long, 12CH, angled	miniature long, 12CH, straight
						
without suction control	78-3100	78-3102	78-3100L	78-3102L	78-9100	78-9102
with suction control	78-3101	78-3103	78-3101L	78-3103L	78-9101	78-9103

Suction handle







Type	Poole angled	Poole straight	large flow 10 mm, Yankauer type	large flow 7 mm, Yankauer type	flat, Yankauer type	miniature with handle, angled, Yankauer type
						
without suction control	78-4100	78-4102	78-5100	78-6100	78-7100	78-8100
with suction control	78-4101	78-4103	78-5101	78-6101	78-7101	78-8101

Suction handle Yankauer type with connecting tube, set

Connecting tube	Type	Yankauer standard, angled	Yankauer standard, straight	Yankauer, bulb tip, angled	Yankauer, sump, angled
					
25 CH/ 2100 mm	without suction control	78-2220	78-2222	78-1220	78-0220
25 CH/ 2100 mm	with suction control	78-2221	78-2223	78-1221	78-0221
25 CH/ 3000 mm	without suction control	78-2320	78-2322	78-1320	78-0320
25 CH/ 3000 mm	with suction control	78-2321	78-2323	78-1321	78-0321
30 CH/ 2100 mm	without suction control	78-2230	78-2232	78-1230	78-0230
30 CH/ 2100 mm	with suction control	78-2231	78-2233	78-1231	78-0231
30 CH/ 3000 mm	without suction control	78-2330	78-2332	78-1330	78-0330
30 CH/ 3000 mm	with suction control	78-2331	78-2333	78-1331	78-0331

C – set with connecting tube with kink-resistant connector to cut, for example 78-2220C

Suction handle Yankauer type with connecting tube, set

Connecting tube	Type	miniature short, 12CH, angled	miniature short, 12CH, straight	miniature short, 16CH, angled	miniature short, 16CH, straight	miniature long, 12CH, angled	miniature long, 12CH, straight
							
20 CH/ 2100 mm	without suction control	78-3260	78-3262	78-3260L	78-3262L	78-9260	78-9262
20 CH/ 2100 mm	with suction control	78-3261	78-3263	78-3261L	78-3263L	78-9261	78-9263
20 CH/ 3000 mm	without suction control	78-3360	78-3362	78-3360L	78-3362L	78-9360	78-9362
20 CH/ 3000 mm	with suction control	78-3361	78-3363	78-3361L	78-3363L	78-9361	78-9363

Suction handle with connecting tube, set

Connecting tube	Type	Poole angled	Poole straight	large flow 10 mm, Yankauer type	large flow 7 mm, Yankauer type	flat, Yankauer type	miniature with handle, angled, Yankauer type
25 CH/ 2100 mm	without suction control	78-4220	78-4222	-	78-6220	-	78-8220
25 CH/ 2100 mm	with suction control	78-4221	78-4223	-	78-6221	-	78-8221
25 CH/ 3000 mm	without suction control	78-4320	78-4322	-	78-6320	-	78-8320
25 CH/ 3000 mm	with suction control	78-4321	78-4323	-	78-6321	-	78-8321
30 CH/ 2100 mm	without suction control	78-4230	78-4232	78-5230	78-6230	78-7230	-
30 CH/ 2100 mm	with suction control	78-4231	78-4233	78-5231	78-6231	78-7231	-
30 CH/ 3000 mm	without suction control	78-4330	78-4332	78-5330	78-6330	78-7330	-
30 CH/ 3000 mm	with suction control	78-4331	78-4333	78-5331	78-6331	78-7331	-
35 CH/ 2100 mm	without suction control	-	-	78-5250	-	78-7250	-
35 CH/ 2100 mm	with suction control	-	-	78-5251	-	78-7251	-
35 CH/ 3000 mm	without suction control	-	-	78-5350	-	78-7350	-
35 CH/ 3000 mm	with suction control	-	-	78-5351	-	78-7351	-







Connecting tubes, drains



- made of medical PVC
- kink-resistant, reinforced lengthwise
- different types of endings
- smooth inside
- double packing
- latex free
- sterile, single use

size I.D./O.D.		5 mm/8 mm		6 mm/9 mm		7 mm/10 mm	
ending type	length	2100 mm	3000 mm	2100 mm	3000 mm	2100 mm	3000 mm
funnel-funnel 		94-0021	94-0031	94-9021	94-9031	94-7021	94-7031
funnel- finger-tip 		94-0024	94-0034	94-9024	94-9034	94-7024	94-7034
funnel- straight end 		93-0021	93-0031	93-9021	93-9031	93-7021	93-7031
bulb end- bulb end 		94-0027	94-0037	94-9027	94-9037	94-7027	94-7037

Connecting tubes, drains

ending type	size O.D. length	20 CH		25 CH		30 CH		35 CH	
		2100 mm	3000 mm	2100 mm	3000 mm	2100 mm	3000 mm	2100 mm	3000 mm
funnel-funnel 		94-6021	94-6031	94-2021	94-2031	94-3021	94-3031	94-5021	94-5031
kink-resistant connector- kink-resistant connector 		-	-	94-2020	94-2030	94-3020	94-3030	94-5020	94-5030
kink-resistant connector to cut - kink-resistant connector 		-	-	94-2022	94-2032	94-3022	94-3032	94-5022	94-5032
kink-resistant connector-finger-tip 		-	-	94-2025	94-2035	94-3025	94-3035	-	-
funnel-straight end 		93-6021	93-6031	93-2021	93-2031	93-3021	93-3031	93-5021	93-5031
kink-resistant connector- straight end 		-	-	93-2020	93-2030	93-3020	93-3030	93-5020	93-5030
kink-resistant connector- male connector 		94-6026	94-6036	94-2026	94-2036	94-3026	94-3036	94-5026	94-5036

Tubing



- made of medical PVC
- transparent, kink-resistant
- possible individual orders for dimensions from 1,3 mm do 14,0 mm

I.D. [mm]	O.D. [mm]	length of coil [m]	reference number
2,7	4,0	100	96-2740
3,1	4,7	100	96-3140
3,6	5,3	100	96-3650
4,2	6,0	100	96-4260
4,7	6,7	50	96-4765
5,3	7,3	50	96-5375
6,0	9,0	50	96-6095
6,2	8,3	50	96-6285
6,6	9,3	50	96-6695
7,0	10,0	50	96-7005
7,4	10,0	50	96-7405
8,0	11,0	50	96-8015
9,0	12,0	50	96-9015
10,0	13,0	50	96-1015

Bubble tubing



- bulb steps 1 m
- made of medical PVC
- transparent, kink-resistant

I.D. [mm]	O.D. [mm]	length of coil [m]	reference number
3,1	4,7	30	97-3143
5,0	8,0	30	97-5083
6,0	9,0	30	97-6093
7,0	10,0	30	97-7003
8,0	11,0	30	97-8013
9,0	12,0	30	97-9013
10,0	13,0	30	97-1013

Silicone tubing



- made of medical grade silicone
- transparent, kink-resistant

I.D. [mm]	O.D. [mm]	length of coil [m]	reference number
4,0	8,0	25	96-S4080
5,0	8,0	25	96-S5080
6,0	9,0	25	96-S6090
6,0	10,0	25	96-S6010
6,0	12,0	25	96-S6012
7,0	10,0	25	96-S7010
8,0	11,0	25	96-S8011
8,0	12,0	25	96-S8012
8,0	14,0	25	96-S8014
10,0	14,0	25	96-S1014
10,0	16,0	25	96-S1016

Tubing connectors

- number coded sizes - marked on the connector
- conical or stepped connectors
- made of medical plastic



T-connectors				
mark	O.D. [mm]	I.D. [mm]	reference number	
			sterile	non-sterile
1	7	5	9T-0710	9T-0700
2	9	6	9T-0910	9T-0900
3	11	9	9T-1110	9T-1100
4	13	10	9T-1310	9T-1300
5	18	14	9T-1810	9T-1800

Y-connectors				
mark	O.D. [mm]	I.D. [mm]	reference number	
			sterile	non-sterile
1	7	5	9Y-0710	9Y-0700
2	9	6	9Y-0910	9Y-0900
3	11	9	9Y-1110	9Y-1100
4	13	10	9Y-1310	9Y-1300
5	16	13	9Y-1610	9Y-1600
6	18	15	9Y-1810	9Y-1800



Universal connector			
O.D. [mm]	I.D. [mm]	reference number	
		sterile	non-sterile
15	6	9P-1510	9P-1500

Straight connectors				
mark	O.D. [mm]	I.D. [mm]	reference number	
			sterile	non-sterile
1	6	5	9P-0510	9P-0500
2	8	6	9P-0610	9P-0600
3	10	9	9P-0910	9P-0900
4	12	10	9P-1010	9P-1000



Finger-tip connector			
O.D. [mm]	I.D. [mm]	reference number	
		sterile	non-sterile
10	6	9F-0610	9F-0600

name	reference number
tubing plug	9Z-2010

Adaptors								
mark	I.D. [mm]	O.D. [mm]		O.D. [mm]		I.D. [mm]	reference number	
		min.	max	max	min.		sterile	non-sterile
1	3	4	6	5	3	2	9R-0310	9R-0300
2	7	8	11	5	3	2	9R-0710	9R-0700
3	8	10	13	10	8	6	9R-0810	9R-0800
4	10	12	15	11	8	7	9R-1010	9R-1000
5	14	16	20	11	8	7	9R-1410	9R-1400

HiCapno

New

HiCapno is a high concentration oxygen mask with possibility to connect CO2 sampling line for capnometry measurements.

It has a built-in unique solution, making possible to take samples of exhaled air for capnometry. This gives immediate view on patients respiratory capacity and enables quick action in case of any abnormalities.

HiCapno oxygen mask has wide variety of uses: emergency care, intensive care units, operating rooms as well as neurosurgeries.

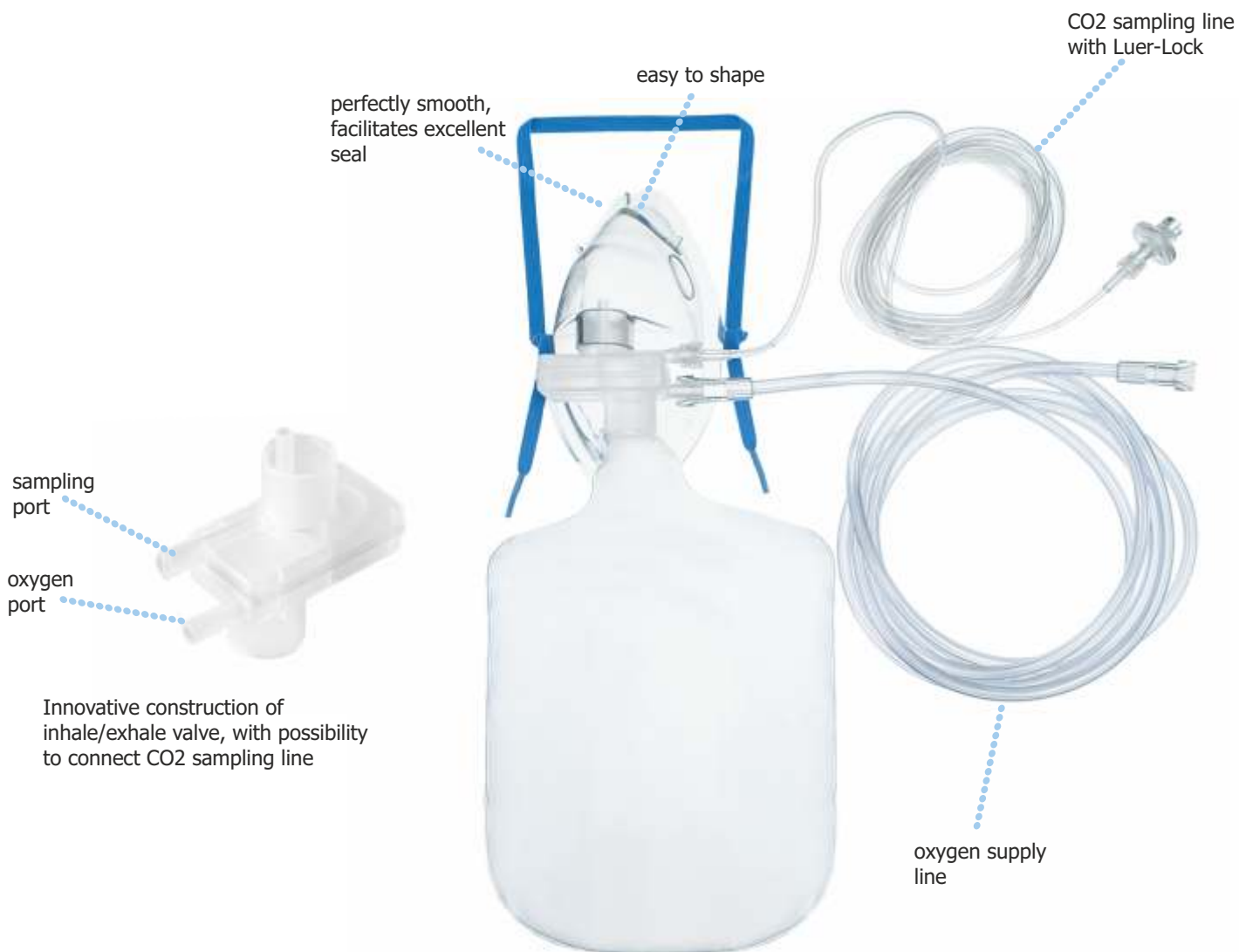

- made of medical, soft transparent PVC
- allows for up to 98% oxygen concentrations
- innovative valve facilitating CO2 sampling for capnometry from exhaled air
- perfectly adheres to face shape, very good seal
- fine packing protecting tube from deformation
- single use

Set components:

- HiCapno oxygen mask with rebreathing bag
- oxygen supply line 2100 mm
- antibacterial filter
- CO2 sampling line with Luer-Lock

type	reference number
set with filter	43-0020

Nasal oxygen set



- made of medical PVC
- soft nasal prongs
- kink-resistant
- available versions: standard, regulated, pediatric
- possible different length of drain
- latex free
- sterile, single use

Typ	length [mm]	reference number
standard phthalate free	1500	43-1000F
	2100	43-1021F
	3000	43-1030
	4000	43-1040
	5000	43-1050
	7000	43-1070
	10000	43-1100
standard	1500	43-1000
	2100	43-1021
regulated phthalate free	1500	43-2000
	2100	43-2021
paediatric phthalate free	1500	43-3000
	2100	43-3021

Oxygen connecting tube



- made of medical PVC
- kink-resistant
- possible different length
- latex free
- sterile, single use

length [mm]	reference number
2100	92-1020
3000	92-1030
4000	92-1040
5000	92-1050
7000	92-1070

Oxygen connecting tube connector

New

- designated for connection of oxygen connecting tubes and nasal oxygen sets
- latex free
- sterile, single use

type	reference number
non-sterile	9P-0700
sterile	9P-0710



Feeding tube



- made of medical PVC
- frosted surface
- colour coded female Luer caps
- marked, two side eyes
- soft, rounded tip
- with graduation and X-ray line
- latex free
- phthalate free
- sterile, single use

size [CH/FG]	colour	length [mm]	reference number
4	Red	400	50-0400
5	White	400	50-0500
6	Yellow	400	50-0600
8	Blue	400	50-0800
10	Black	400	50-1000
12	White	400	50-1200
4	Red	1000	51-0400
5	White	1000	51-0500
6	Yellow	1000	51-0600
8	Blue	1000	51-0800
10	Black	1000	51-1000
12	White	1000	51-1200

Control valve suction catheter



- made of medical PVC
- frosted surface
- colour coded connectors
- two side opposite eyes
- latex free
- sterile, single use



type	size [CH/FG]	colour	length [mm]	reference number
straight	6	Yellow	400	71-0600
	8	Blue	400	71-0800
	10	Black	600	71-1000
	12	White	600	71-1200
	14	Orange	600	71-1400
	16	Green	600	71-1600
	18	Red	600	71-1800
straight, graduation mark	4	Red	400	71-0420
	5	White	400	71-0520
	6	Yellow	400	71-0620
	8	Blue	400	71-0820
	10	Black	600	71-1020
	12	White	600	71-1220
	14	Green	600	71-1420
	16	Orange	600	71-1620
curved, graduation mark	8	Blue	400	71-0880
	10	Black	600	71-1080
	12	White	600	71-1280
	14	Green	600	71-1480
	16	Orange	600	71-1680
	18	Red	600	71-1880

Stomach tube



- made of medical PVC
- frosted surface
- colour coded connectors
- two side eyes
- latex free, phthalate free
- sterile, single use

size [CH/FG]	colour	reference number		
		800 mm		1000 mm
		-	-	introducer
8		55-0800	56-0800	-
10		55-1000	56-1000	-
12		-	56-1200	56-1260
14		-	56-1400	56-1460
16		-	56-1600	56-1660
18		-	56-1800	56-1860
20		-	56-2000	56-2060
22		-	56-2200	56-2260
25		-	56-2500	56-2560
28		-	56-2800	-
30		-	56-3000	-
32		-	56-3200	-
35		-	56-3500	-

Duodenal tube

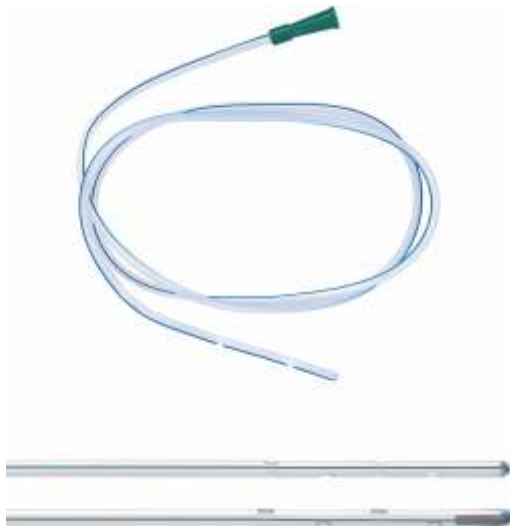

- made of medical PVC
- frosted surface
- colour coded connectors
- four lateral eyes
- length 1250 mm
- available versions:
 - with introducer and X-ray line
 - with central opening and X-ray line
 - with olive and X-ray line
- latex free, phthalate free
- sterile, single use

size [CH/FG]	colour	reference number			
		-	introducer	central opening	olive
8		60-0800	-	61-0800	62-0800
10		60-1000	-	61-1000	62-1000
12		60-1200	60-1260	61-1200	62-1200
14		60-1400	60-1460	61-1400	62-1400
16		60-1600	60-1660	61-1600	62-1600
18		60-1800	60-1860	61-1800	62-1800
20		60-2000	60-2060	61-2000	62-2000
22		60-2200	60-2260	61-2200	-
25		60-2500	60-2560	61-2500	-

Urology catheters



- made of medical PVC
- colour coded connectors
- frosted surface
- soft, rounded tip
- latex free
- sterile, single use

size [CH/FG]	colour	length [mm]	reference number			
			female Nelaton	Nelaton	Tiemann	Couvelaire
6		180	80-0600			
8		180	80-0800			
10		180	80-1000			
12		180	80-1200			
14		180	80-1400			
16		180	80-1600			
18		180	80-1800			
6		400		81-0600	82-0600	-
8		400		81-0800	82-0800	83-0800
10		400		81-1000	82-1000	83-1000
12		400		81-1200	82-1200	83-1200
14		400		81-1400	82-1400	83-1400
16		400		81-1600	82-1600	83-1600
18		400		81-1800	82-1800	83-1800
20		400		81-2000	82-2000	83-2000
22		400		81-2200	82-2200	83-2200
25		400		81-2500	82-2500	83-2500



Предприятие SUMI было основано в 1988 году. Фирма расположена в городе Сулеювке на экологически чистой территории, в 20 километрах от центра Варшавы. Современное оборудование и высший стандарт производственных помещений постоянно обеспечивают сохранение высокого качества изготавливаемых изделий.



Нашей надежной опорой является квалифицированный и опытный персонал, выполняющий свою работу умело и ответственно на каждом этапе производства. За всеми производственными процессами тщательно следит опытный руководящий коллектив и специалисты в области обработки пластических масс, развития и качества, а также маркетинга.



Более, чем 30-летний опыт производства медицинских расходных материалов позволяет признавать нас надежным и заслуживающим доверия партнером в области медицины.





**SUMI spółka z ograniczoną
odpowiedzialnością sp. k.**

05-070 Sulejówek, Drobiarska 35

Poland

tel. +48 22 783 30 23 fax +48 22 783 30 25

e-mail: sumi@sumi.com.pl

<http://www.sumi.com.pl>